

# GEO MICRO DISTRICT

---

Feasibility Study



BUROHAPPOLD  
ENGINEERING

# Table of Contents

<b>Executive Summary</b>	<b>1</b>	<b>Appendix A: Technology Background</b>	<b>48</b>
<hr/>		<hr/>	
<b>Chapter I: Introduction</b>	<b>4</b>	1 Introduction to Heat Pumps	48
<hr/>		2 Ground-Coupled Heat Pumps	48
1 Project Context	4	3 Groundwater Heat Pumps	51
2 Feasibility Study Approach	4	4 Surface-Water Heat Pumps	53
3 Heat Pump Systems	6		
4 GeoMicroDistricts	7	<b>Appendix B: Case Studies</b>	<b>56</b>
		<hr/>	
<b>Chapter II: Site Conditions</b>	<b>10</b>	1 Stockton University	56
<hr/>		2 West Union District System	56
1 Thermal Sources	10	3 Furman University	57
2 Land Use Patterns	16	4 Ball State University	57
3 Building Energy	19	5 South Caribou Recreation Centre	58
		6 Alexandra District Energy Utility	59
<b>Chapter III: Engineering Feasibility</b>	<b>24</b>		
<hr/>		<b>Appendix B: Policies and Regulations</b>	<b>60</b>
1 Prototypical Street Segments	24	<hr/>	
2 GSHP System Selection	24	1 Federal Policies and Programs	60
3 GSHP System Design	28	2 State Policies and Programs	61
4 GSHP System Performance	30	3 Regulations and Permitting	64
<b>Chapter IV: Economic Feasibility</b>	<b>34</b>	<b>Acronyms and Abbreviations</b>	<b>67</b>
<hr/>		<hr/>	
1 GSHP Installation Costs	34		
2 GSHP Operating Costs	38		
3 Building Conversion Costs	40		
<b>Chapter V: Conclusion</b>	<b>44</b>		
<hr/>			
1 Findings	44		
2 Key Considerations	45		
3 Next Steps toward Change	47		

# Executive Summary

## Aging Gas Infrastructure

Natural gas accounts for the majority of the energy use in Massachusetts.<sup>1</sup> Yet more than a quarter of the gas pipes under Massachusetts streets are aging, and must be replaced over the next 20 years. This work will cost gas customers more than \$9 billion.<sup>2</sup>

An investment of this scale in fossil-fuel infrastructure is in direct opposition to the State's mandate to reduce emissions 80 percent by 2050. Moreover, because the cost of replacement is spread over 40 years, gas customers, who will ultimately pay for this work, may be funding an obsolete, or "stranded" infrastructure network.

However, aging gas infrastructure in Massachusetts can create an opportunity rather than a problem. The residents and businesses of Massachusetts must decide whether to continue on current trajectory or pursue new paths. The investment must be made, but what type of infrastructure should define our collective future?

## The GeoMicroDistrict

This Study explores the feasibility of replacing aging gas infrastructure in Massachusetts with ground-source heat pump (GSHP) systems shared by buildings along a single street segment, or "GeoMicroDistricts." As gas pipes are replaced, individual GeoMicroDistricts could interconnect to form increasingly larger and more efficient systems that could be managed by a thermal distribution utility.

This Study used the best available data on Massachusetts geology, land use, and existing building thermal energy use to assess the feasibility of GSHP systems against typical conditions encountered throughout the state, specifically areas

in existing gas utility territories.<sup>3</sup> Street-segment prototypes were then created to represent those conditions at the scale of a GeoMicroDistrict.

Various GSHP systems were evaluated for their ability to meet the heating and cooling loads of street-segment prototypes identified. This Study assumed that an ambient temperature loop, installed within an existing gas utility right-of-way, would provide an interface between loops in the ground and individual buildings. Each building would provide its own heat pump to transfer thermal energy between the ambient loop and its heating and cooling distribution systems.

## Meeting Thermal Energy Needs

Ultimately, vertical group-coupled systems provided the best performance across street-segments, meeting 100 percent of the heating and cooling needs of buildings in low to medium density residential and mixed-use commercial districts. However, the imbalance between seasonal heating and cooling loads poses a challenge, as it may result in long-term changes to ground temperatures.

GeoMicroDistricts can resolve this issue by interconnecting a variety of heating loads, and providing a centralized system for supplemental heating and cooling. For example, the surplus of cooling capacity typical to a residential-only area may be offset by the higher cooling loads of a neighboring mixed-use or commercial street. This Study found that the larger and more energy-diverse the system, the better the overall performance. This performance improves as GeoMicroDistricts interconnect and grow, as do the costs of operation.

Further, additional capacity can be created by connecting GeoMicroDistricts with surface water heat pump system (i.e., lakes and rivers), or various other heat sources and sinks. These may range from solar hot water panels to the cooling systems of industrial freezers, ice and hockey rinks, or other producers of waste heat.

<sup>1</sup> Gas provides 46 percent of electric generation and 51 percent of residential heating. Northeast Gas Association. 2017 State of the Industry Report: "Natural Gas in Massachusetts," 2017.

<sup>2</sup> Calculated by multiplying the number of miles left to replace by the current average cost per mile, according to Massachusetts Department of Public Utilities, 18-GLR-01 Gas Leaks Report, December 2018.

<sup>3</sup> We appreciate the support and data provided by the Massachusetts Clean Energy Center (MassCEC), Massachusetts Department of Energy Resources (DOER), Grey Edge Group, Eversource Energy, and the wealth of information made publicly available by the Massachusetts Bureau of Geographic Information (MassGIS).

# Technical Feasibility: GCHP Closed Vertical

Annual Thermal Energy Loads Met (Interconnected)

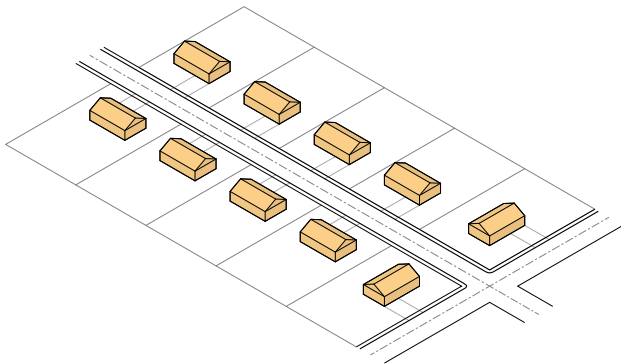
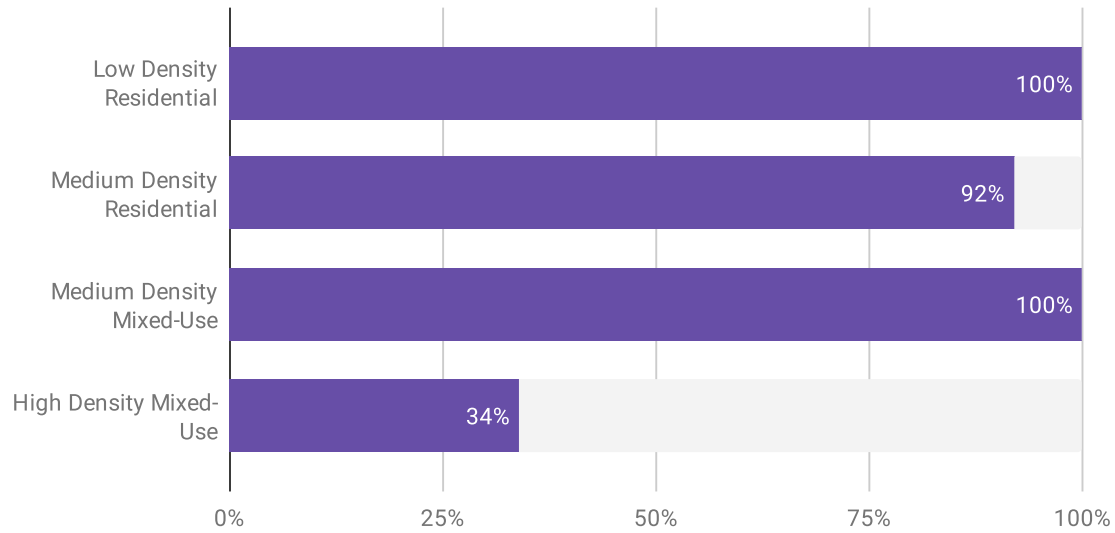

Low Density Residential

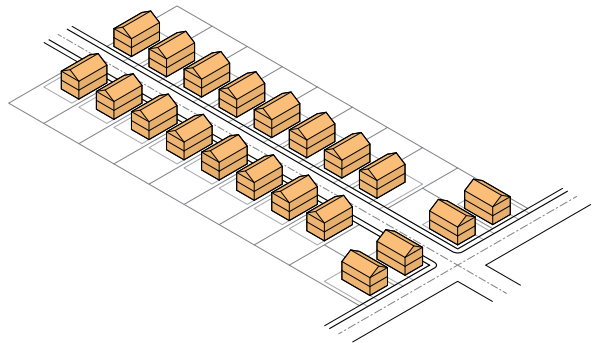

Medium Density Residential

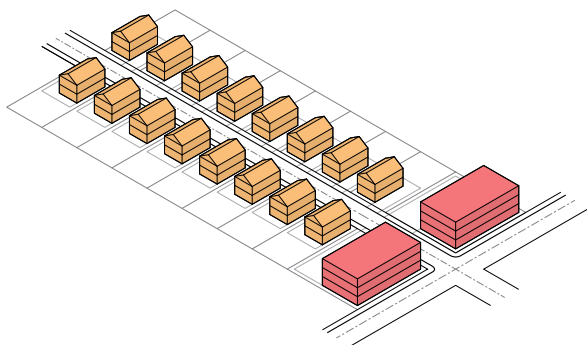

Medium Density Mixed-Use

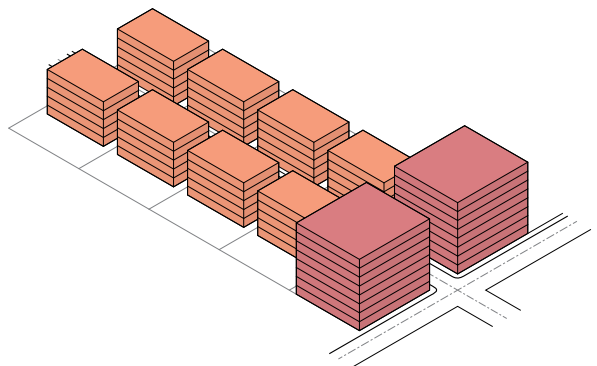

High Density Mixed-Use

## Lower Energy Costs

The price of thermal energy purchased from a GeoMicroDistrict depends on a number of factors, but is ultimately decided by the Massachusetts Department of Public Utilities ratemaking process. However, unlike natural gas heating, the source of energy for a GeoMicroDistrict is effectively free. There is no fuel cost other than that for the electricity used to power the various pumps and controls. As a result, rates would only reflect the cost of installing and maintaining the system, and customers and utilities are protected from severe fluctuation in fuel prices. Therefore, it is possible to provide thermal energy at rates lower than those for gas.

## Speed and Scale of Implementation

The GeoMicroDistrict is a utility-scale approach that re-purposes the existing public utility structure, financing, workforce, and customer base to deliver safe, clean, and affordable heating and cooling. This enables a larger, more rapid, and equitable transition to clean energy than the current building-by-building approach.

An interconnected, renewable thermal energy network also creates benefits for the electricity grid. The use of a GSHP system for cooling would reduce electricity demand during summer peaks, limiting strain on the grid and the potential for outages. Moreover, as buildings move towards electrified sources of heating and cooling, GSHP systems can help lower overall electricity consumption and help utility customers avoid the cost of adding new capacity.

The GeoMicroDistrict represents one side of an energy system composed of two synergistic grids—heat and power, or pipes and wires—that together facilitate a more rapid and equitable transition to clean energy.

## Safety Now and in the Future

A GeoMicroDistrict creates much less of a risk to public health than a network of gas pipes, an issue that is critical to Massachusetts given the recent gas

disaster in Merrimack Valley and ongoing smaller disasters. Rather than potentially explosive fuel, a GeoMicroDistrict circulates water at around the temperature of tap water, and a pressure close to that of a garden hose.

More importantly, the replacement of gas boilers and furnaces with a GSHP system would result in a significant reduction in greenhouse gas (GHG) emissions. A GeoMicroDistrict could reduce GHG emissions from heating, cooling, and hot water for a typical street segment by nearly 60 percent. Further, GHG emissions associated with the electricity required to operate a GSHP system would decrease over time as the electricity grid adds more renewable energy capacity.

The GeoMicroDistrict thus increases safety now and in the future, providing a safe and clean alternative to natural gas for Massachusetts residents and businesses. It presents a viable strategy to help avert the global climate crisis.

## Driving Forward System Change

HEET is actively working with the State and local governments, utility companies, and customers to identify potential locations for one or more GeoMicroDistrict pilot projects in Massachusetts. These pilot projects will provide essential information on the performance and cost of installing and operating a GeoMicroDistrict. HEET and a group of project partners will identify sites in late 2019, with the intention of breaking ground in 2020.

Following successful pilot(s), HEET plans to drive forward the transition from natural gas to clean energy by creating a renewable thermal grid (or “HEET Grid”) from the bottom up, at the speed and scale that this moment in history demands. This Study concludes that the GeoMicroDistrict provides a viable means to achieve this goal, and the implementation of a pilot project is the most important next step in facilitating the transition.

# Chapter I: Introduction

## 1 Project Context

Natural gas is a significant source of energy for buildings in Massachusetts, accounting for 46 percent of electric generation capacity and 51 percent of residential heating.<sup>1</sup> However, Massachusetts has one of the oldest natural gas distribution systems in the country, with more than 6,000 miles of aging and leak-prone pipes, or approximately 26 percent of the distribution system. Based on this information, HEET has estimated that the replacement of this infrastructure, which is expected to take two or more decades to complete, could ultimately cost utility customers more than \$9 billion.<sup>2</sup>

Beyond the safety risk that these leaks pose, natural gas is also a significant contributor of greenhouse gas (GHG) emissions. In addition to the emissions produced when natural gas is combusted to produce heat and electricity, gas leaks also release methane, a GHG that is 34 times more potent than carbon dioxide over the first 100 years it is in the atmosphere. Reported gas leaks in 2017 alone emitted more than 55,000 metric tons of methane—equivalent to the GHG emissions from driving 300,000 cars for a year.<sup>3</sup>

This Study is intended to explore the feasibility of replacing aging gas infrastructure in Massachusetts with street-scale ground-source heat pump (GSHP) systems, or “GeoMicroDistricts,” and interconnecting them over time to create a larger thermal distribution system. This strategy is intended to help improve public health and safety, reduce GHG emissions, facilitate a faster and more just transition to renewable energy, and redirect investment to a long-term solution for heating and cooling buildings.

This Study was conducted by BuroHappold Engineering on behalf of HEET (Home Energy Efficiency Team, a Massachusetts 501(c)3 nonprofit) as part of their wider efforts to increase energy

efficiency, cut fugitive methane emissions from gas leaks in Massachusetts, and facilitate the transition to renewable energy and power.

This Study was generously funded by the Winslow Foundation. It represents the first step in a long-term initiative to implement and scale the GeoMicroDistrict concept. HEET would also like to thank the Barr and Putnam Foundations and the many generous donors that support this work.

## 2 Feasibility Study Approach

The primary objectives of this Study are to:

- Identify GSHP systems suitable for street-scale heating and cooling in Massachusetts.
- Determine the engineering feasibility and capacity of certain street-scale GSHP systems.
- Evaluate the economic viability of implementing a district- or street-scale GSHP systems as an alternative to natural gas.<sup>4</sup>

To achieve these objectives, BuroHappold combined extensive research and analysis of building and site conditions throughout Massachusetts with a detailed evaluation of the performance of certain GSHP systems for a number of prototypical conditions.

This Study was greatly supported by the advice and guidance of experts from Eversource, the Massachusetts Clean Energy Center (MassCEC), the Massachusetts Department of Energy Resources (DOER), and the GreyEdge Group, among others.

The engineering feasibility and capacity of GSHP systems depends on various site-specific factors, including the properties of available thermal sources and the heating and cooling needs of connected buildings. To account for these factors, this Study began with an analysis of site conditions throughout Massachusetts to identify common geological and hydrological characteristics, primary

1 Northeast Gas Association. 2017 State of the Industry Report: “Natural Gas in Massachusetts,” 2017. See also Massachusetts Department of Public Utilities, 18-GLR-01 “Report to the Legislature on the Prevalence of Natural Gas Leaks in the Natural Gas System,” December 27, 2018.

2 Assumes replacement of remaining leak-prone infrastructure and average replacement cost based on the Massachusetts Department of Public Utilities 18-GLR-01 “Natural Gas Leaks” report.

3 Massachusetts Department of Public Utilities, 18-GLR-01 Gas Leaks Report, December 2018. Greenhouse gas equivalent based on the U.S. Environmental Protection Agency’s Greenhouse Gas Equivalencies Calculator.

4 Although the terms “district-scale” and “street-scale” can both be used to describe systems that provide heating and cooling from a central source to individual buildings within a given area, “street-scale” is generally used throughout this Study to indicate that the proposed system is limited to a single street segment—the length of a street between intersections or an intersection and a dead end.

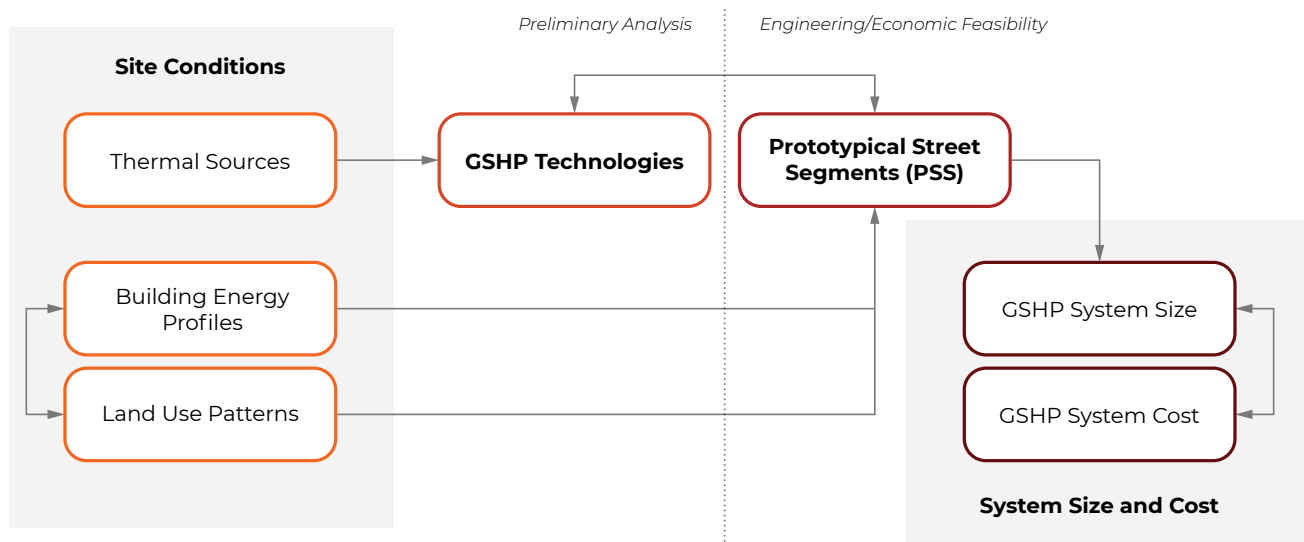

Figure I-1: Feasibility Study assessment process

land uses and typical land use patterns, and typical energy consumption for common building types. A concurrent study of GSHP technologies was performed to understand the key parameters driving system size and capacity. Applicable State and local policies and regulations were also reviewed to understand the barriers and opportunities for implementing certain GSHP system.

The preliminary analysis informed the development of four “Prototypical Street Segments” (PSS) representing a range of typical conditions. Each PSS was used as a case study to model the engineering and economic feasibility of a particular GSHP system. They may also serve as a guide for selecting the most viable conditions for successful implementation. The potential capacities of selected GSHP systems were estimated based on the available area and site conditions of the different PSS.

Aggregated heating and cooling loads for PSS buildings were then calculated to determine whether such loads could be met by those GSHP systems, and further optimized to address long-term capacity issues, which are discussed later in this Study. Finally, an economic analysis was performed to estimate the potential initial and ongoing costs of implementing a street-scale GSHP system and converting the connected buildings.

This findings of this Study, and additional information related to the evaluation and design of GSHP systems, are organized into the following chapters:

- **Chapter I**, in addition to the Feasibility Study approach above, provides an overview of heat pump technologies and the GeoMicroDistrict concept.
- **Chapter II** describes typical site conditions in Massachusetts and their effect on the performance of certain GSHP systems.
- **Chapter III** describes the approach and findings of the engineering feasibility study.
- **Chapter IV** describes the approach and findings of the economic feasibility study.
- **Chapter V** summarizes the key findings of this Study and the next steps for GeoMicroDistrict implementation.

Additional background information on the GSHP technologies mentioned is provided in Appendix A of this Study. Case studies representing district-scale GSHP systems installed in North America are presented in Appendix B. State and federal policies related to GSHP systems, including regulations and incentive programs, are summarized in Appendix C.

### 3 Heat Pump Systems

A heat pump is a device that transfers thermal energy from a high temperature heat source to a low temperature heat sink. Heat pumps operate in the same way that a water pump transfers fluid from a body of water (i.e., the source), such as a flooded basement, to another vessel or area (i.e., the sink), such as a bucket or backyard. However, unlike water pumps, which use mechanical action to move the fluid, heat pumps use electrical energy to circulate a heat transfer medium that carries heat from one location to another.

Heat pumps provide the cooling for our refrigerators and freezers and are becoming a common means of providing space heating and cooling in buildings throughout the world. Heat pumps can extract or release heat energy from a variety of sources, including the air, water, and ground.

It is important to understand that heat pumps are not limited to the temperatures of their respective sources and sinks—a modern heat pump can heat a home through a New England winter and provide cooling during a summer heat wave. However, the efficiency of a heat pump declines as the difference between temperatures increase. **This is why a thermal source such as the ground, which is less susceptible to annual fluctuations in temperature, yields better performance.**

#### 3.1 Air-Source Heat Pumps

An air-source heat pump (ASHP) provides space heating and cooling using outdoor air as a thermal source. Typically, an ASHP is relatively inexpensive to operate compared to traditional heating and cooling equipment. This is because less energy is required to move heat than it is to convert it from a fuel source (e.g., the combustion of natural gas for heating).

As mentioned earlier in this Chapter, ASHP performance decreases as the difference between ambient outdoor and indoor air temperatures increase. In very cold climates there is also a risk of frost forming on the outdoor components of the ASHP system, which further increases the difference between temperatures and decreases heating efficiency.

Because of these issues, the use of ASHP systems was once limited to warmer and more moderate climates. However, improvements in heat pump technology have made them a legitimate alternative to fossil fuel space heating in colder regions such as New England.<sup>5</sup>

#### 3.2 Ground-Source Heat Pumps

A ground-source heat pump (GSHP) provides heating and cooling using the ground, groundwater, or surface water as a thermal source. A GSHP system consists of a network of piping, referred to in this Study as a “GSHP loop,” that is run through one or more boreholes, wells, or trenches, or may sit directly in a body of water.

The heat pump unit is typically installed within the building served or a central utility plant. The heat pump exchanges heat from the GSHP loop with the building’s heating and cooling distribution systems. The heat pump also regulates the flow of circulating fluid, which is typically water or water with an antifreeze solution, through the GSHP loop to facilitate the transfer of thermal energy.

GSHP systems may be grouped into three further categories based on the thermal source used; each is described in greater detail in Appendix A of this Study:

- A **ground-coupled heat pump (GCHP)** exchanges thermal energy with the ground using a series of vertical boreholes or horizontal trenches.
- A **groundwater heat pump (GWHP)** exchanges thermal energy with existing groundwater sources (e.g., aquifers) using one or more wells.
- A **surface-water heat pump (SWHP)** exchanges thermal energy with certain surface water bodies (e.g., lakes, ponds, rivers) that maintain a relatively stable water temperature throughout the year.

In a typical configuration, the thermal energy transferred by the circulating fluid is exchanged within the building through either a water-to-air or water-to-water heat pump. Water-to-air heat pumps are typically coupled with central forced-air distribution systems that use fans and ductwork to circulate air that has been heated or cooled by the heat pump throughout the building.

<sup>5</sup> U.S. Department of Energy, Air-Source Heat Pumps. <https://www.energy.gov/energysaver/heat-pump-systems/air-source-heat-pumps>



Water-to-water heat pumps are typically coupled with hydronic systems that distribute fluid that has been heated or cooled by the heat pump to “terminal units” (e.g., radiators, radiant panels, baseboard convectors) in individual building spaces. Hydronic systems can provide simultaneous heating or cooling to individual units if they are arranged in a three- or four-pipe configurations that provide separate supply and return lines for hot and chilled water. The fluid distributed through a hydronic system is separate from the circulating fluid within the GSHP loop.

A well-designed GSHP system has several benefits over an ASHP. First, as mentioned earlier in this Chapter, the performance of a GSHP system is not affected by ambient air temperature. This results in less energy consumption and reduces the need for supplementary heating or cooling. Further, GSHP systems are not susceptible to frosting, as the outdoor components are typically buried below the frost line or submerged.

Finally, although the conditions for calculating rated efficiency are different for the two system types, the efficiency ratings for GSHP systems are typically higher than those for ASHPs.<sup>6</sup>

## 4 GeoMicroDistricts

**A GeoMicroDistrict is a novel combination of existing technology, combining GSHP systems with an approach based on micro-grid and utility-scale thermal energy management practices.**

Traditional district energy systems provide heating and cooling to individual buildings within a block, neighborhood, or district. In most cases, the heating or cooling supply is produced at a central location, such as a utility plant, and distributed to individual buildings through a network of pipes. Heating is often produced by a boiler or combined heat and power (CHP) engine that produces electricity and heat simultaneously. Cooling is often provided by chillers and may be stored on site for later distribution.

Many older cities in the United States have provided district steam heating for more than a century, and many colleges and universities in the country operate a district-scale system that circulates steam, hot water, and/or chilled water to campus buildings.

### Geothermal Energy Terminology

The term “geothermal energy” generally refers to the energy stored within the earth. Geothermal energy may be used for various applications depending on the quality of heat and thermal conductivity, and geothermal systems may be broadly categorized either as deep or enhanced, or as shallow systems based on these properties.

“Deep geothermal systems” rely on the high quality heat found deep—typically 10,000 feet or more—beneath the earth’s surface or in naturally-occurring resources such as hot springs. Steam and hot water from these resources may be used to produce electricity or provide heating and hot water directly. In the case of electricity production, steam produced by the resource or created by high temperature hot water is used to spin turbine generators. These systems can be cost-competitive with other forms of electricity generation in regions with volcanic activity or high hydrothermal potential.

“Shallow geothermal systems” rely on the relatively stable temperature of the ground, groundwater, or certain surface water bodies. In contrast to deep geothermal resources, which can be understood as energy producers, shallow geothermal resources are better understood as energy reserves. Ground-source heat pump (GSHP) systems are able to access these reserves to provide highly efficient building heating and cooling.

It should be noted that a variety of similar terms, such as “geothermal heat pumps,” “geo-exchange systems,” and “ground-source systems” are often used to describe shallow geothermal and GSHP systems. This Study uses the terminology established by the American Society of Heating, Refrigerating and Air-Conditioning Engineers (ASHRAE) to maintain consistency with existing technical guidelines.

<sup>6</sup> American Society of Heating, Refrigerating and Air-Conditioning Engineers, “HVAC Applications,” 2015.

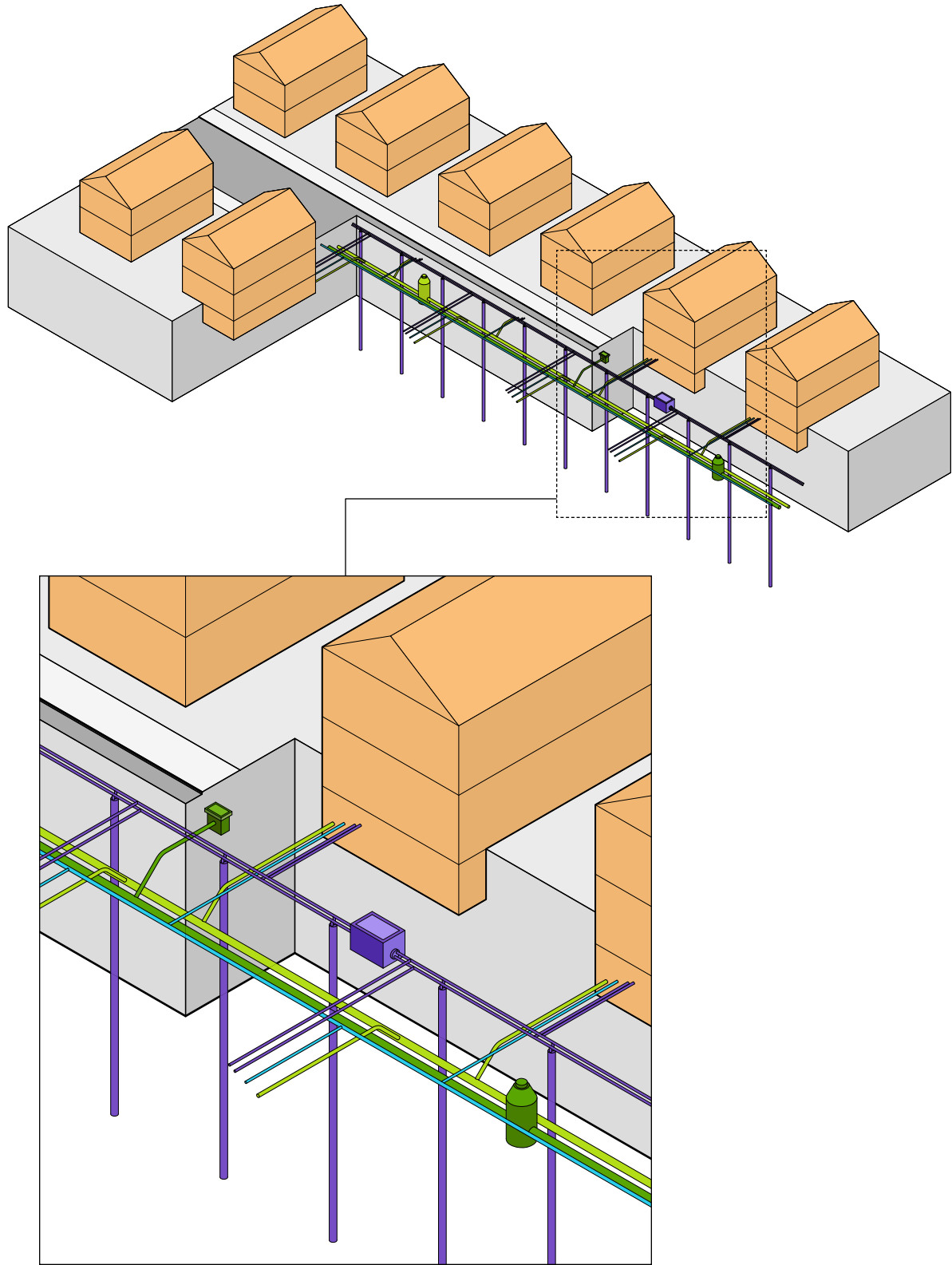

Figure I-2: Illustration of a GeoMicroDistrict (purple) with a line of boreholes along an existing gas utility corridor.

The GeoMicroDistrict shifts energy generation away from the central plant model to a more distributed, localized source of generation.

Currently, a majority of GSHP systems within the United States are installed as independent systems serving a single building, although some larger scale systems have become more common in college and university campuses and new large-scale residential development projects. Although district GSHP systems may include a central plant to facilitate pumping or other functions, they rely on GSHP loops installed at one or more locations distributed throughout the site to provide heating and cooling. Further, in cases where heat pumps are located within individual buildings, district GSHP systems can distribute water at ambient ground temperatures, minimizing heat loss and reducing the amount of insulation required.

The term “GeoMicroDistrict” was introduced by HEET to define a scalable GSHP system serving a single street segment—a length of street between two intersections or an intersection and a dead end—and installed primarily in the public right-of-way (ROW), that is intended to be interconnected to form a thermal grid, or “HEET Grid.” A GeoMicroDistrict could start as a single street-scale GSHP system and grow as adjoining streets were converted, providing greater efficiency as a greater diversity of loads are connected, while benefiting further from economies of scale.

Through this growth, a HEET Grid could be built at the scale of a city or entire state to provide resilient, renewable thermal energy in an efficient and optimized design. A large scale thermal energy network would also create benefits for the electricity grid by reducing demand for electricity during summer peaks. The reduced strain on the grid during these times would limit the potential for power outages, helping utility customers avoid the long-term costs of adding new capacity.

GeoMicroDistricts would use the existing ROW corridor occupied by natural gas infrastructure to distribute heating and cooling to individual buildings.<sup>7</sup> GSHP loops could be located within the existing gas corridor, across the unoccupied portions of the ROW, or on adjacent properties (e.g., yards, parks, parking lots, and water bodies). Small pumping stations or utility vaults would be used to house pumps to move the circulating fluid.

Where additional heating or cooling is needed to supplement the GSHP system, central utility sheds or similar structures could house natural gas boilers and electric chillers to meet the remaining demand. Gas-fired equipment would be phased out as the system grows or alternatives become available. Heat pumps would be located within individual buildings to minimize the amount of infrastructure needed within or around the street and provide individual customers a greater degree of control.

---

<sup>7</sup> This requires the replacement of all gas-fired appliances in the affected buildings—including domestic hot water (DHW) heaters, gas stoves and ovens, and gas-fired clothes dryers—with electric models.

# Chapter II: Site Conditions

## 1 Thermal Sources

GSHP systems exchange heat with the ground, groundwater, or surface water, all of which provide relatively constant temperatures for heat exchange compared to outdoor air. For any thermal source and corresponding GSHP system, it is essential to establish an understanding of key geological and hydrogeological parameters that determine thermal properties of each thermal source, as these parameters will dictate the design and ultimate capacity of the GSHP system selected. Further, it is worth noting that the GeoMicroDistrict approach facilitates the capture of anthropogenic thermal sources, such as waste heat from data centers, hockey rinks, or factories.<sup>1</sup>

### 1.1 Ground

For the purposes of this Study, ground characteristics were evaluated in terms of two broad categories: superficial geology and bedrock. Within each category, variations in composition, thickness, and hydraulic properties influence temperature, thermal conductivity, thermal diffusivity, and moisture content, all of which contribute to the performance of GCHP and GWHP systems.<sup>2</sup> Because of this, testing and the careful interpretation of geological information and associated thermal properties is essential for any site prior to the selection and design of a GSHP system. **GSHP system design is always site specific.**

#### 1.1.1 Surficial Geology

Surficial geology refers to the layers of soil and loose or unconsolidated sediment deposits located at or near the earth's surface. These layers may range in thickness from a few to a few hundred feet, although in some cases soils and sediment are absent and bedrock reaches the surface.

Surficial geology in Massachusetts may be divided into three broad categories based on their origin and composition:

- Glacial till and moraine deposits: Unsorted mixtures of sand, silt, gravel, and moraines (i.e., glacial debris ranging in size from fine-grained particles to large boulders).
- Glacial stratified deposits: Layers of well- to poorly-sorted gravel, sand, silt, and clay that are concentrated in valleys and lowland areas.
- Post-glacial deposits: Floodplain alluvium (i.e., loose, unconsolidated soil or sediment deposited by flowing streams or rivers) and swamp deposits.<sup>3</sup>

The thermal capacity of superficial geology is determined by the thickness of a given layer, its temperature, and its composition—specifically moisture content and the grain size of soil or sediment particles.

The proportion of coarse-grained to fine-grained particles also influences thermal conductivity (i.e., the ability to transfer heat) and thermal diffusivity (i.e., the rate of heat transfer).<sup>4</sup> The overall thermal conductivity and diffusivity for a given location determines the ground temperature variation, which affects the performance of the GSHP system.

Variations in ground temperature typically decrease with depth, and the overall efficiency of GCHP systems will depend on how deep the loop is buried. At a depth of 16 feet or more, the annual variation in temperature is almost negligible. However, even layers more shallow than 16 feet can have a near-constant temperature, making them suitable for GSHP applications.<sup>5</sup>

Of the GSHP technologies considered in this Study, the performance of horizontal closed GCHP systems is almost entirely defined by soil characteristics.

#### 1.1.2 Bedrock

Bedrock generally provides predictable and high thermal conductivity. Bedrock is typically deeper than the surficial materials previously described, and

<sup>1</sup> See Appendix D of this Study.

<sup>2</sup> NYC Department of Design and Construction, "Geothermal Heat Pump Manual." 2013.

<sup>3</sup> U.S. Geological Survey, "Surficial Materials of Massachusetts." 2018.

<sup>4</sup> American Society of Heating, Refrigerating and Air-Conditioning Engineers, "Geothermal Heating and Cooling: Design of Ground-Source Heat Pump Systems (GSHP)." 2014.

<sup>5</sup> Alaska Center for Energy and Power, "Ground Source Heat Pumps in Cold Climates." 2011.



Figure II-1: Surficial Geology in Massachusetts (source: MassGIS)

## Surficial Geology

Total Area by Geology Type

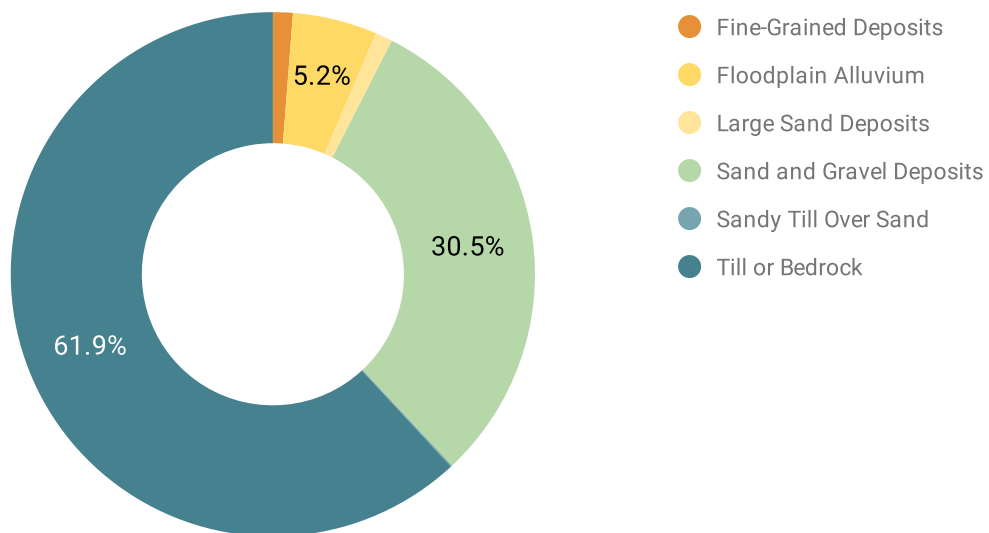

Figure II-2: Surficial geology by total surface area (source: MassGIS, BuroHappold Analysis)

# Bedrock Depth

Bedrock Depth Distribution

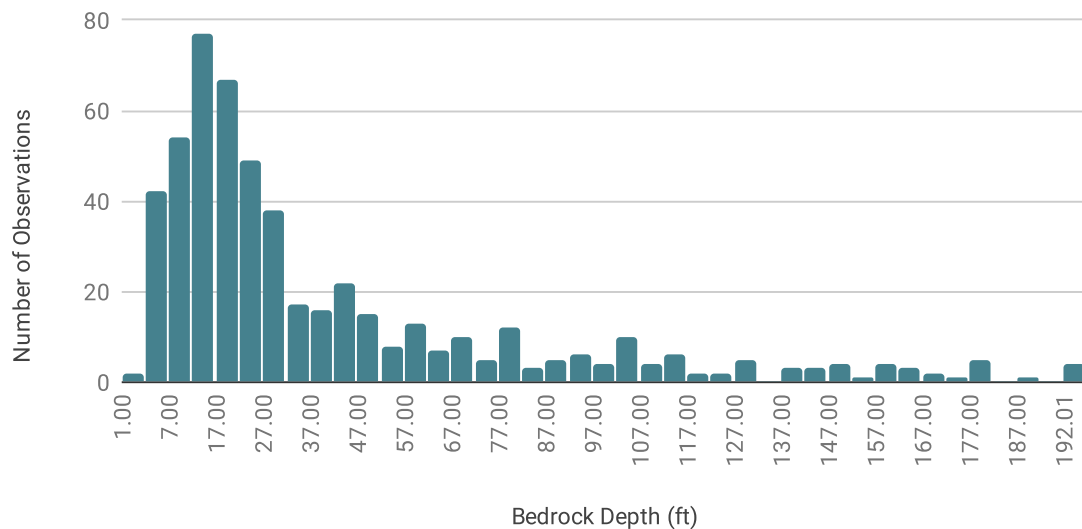

Figure II-3: Observed bedrock depth in Massachusetts (source: MA EEA, BuroHappold Analysis)

are the result of geologic processes that occurred billions of years ago.<sup>6</sup> Groundwater can permeate fractured bedrock formations, and bedrock aquifers are created by the accumulation of ground water in large fractures. Shallow bedrock (i.e., less than 100 feet deep) tends to be more fractured than deeper formations, which are more consolidated due to pressure.

Metamorphic and igneous bedrock formations are typical in Western Massachusetts, whereas sedimentary and granite formations are more common in the Greater Boston area. Much of the Cape is composed of unconsolidated sediments rather than bedrock.<sup>7</sup> On average, bedrock formations in Massachusetts are approximately 5,000 feet thick, and can be found starting at a depth of approximately 35 feet.<sup>8</sup>

The specific thermal capacity of bedrock depends on composition, depth, and the presence and flow of groundwater. In terms of composition, granite and metamorphic rocks generally provide higher thermal conductivity. Where groundwater is

present, both GCHP and GWHP systems are viable options, although the feasibility of a GWHP system depends on water quality and production at the site.

In addition to thermal capacity, certain bedrock characteristics can increase or decrease the difficulty and cost of borehole or well drilling. Deep bedrock formations situated beneath loose, unconsolidated sediment may require a significant amount of reinforcement to prevent the hole from collapsing. Conversely, drilling through hard bedrock formations that begin at a shallow depth may require more time, increasing labor costs.

## 1.2 Groundwater

Groundwater is the result of precipitation and surface water bodies percolating through soil, sediment, and bedrock layers. Groundwater may flow between rocks and sediment or accumulate in large faults or fractures as aquifers. Similar to soil, it maintains a relatively constant temperature compared to ambient air, and is the primary thermal source for GWHP systems. The presence

6 MassGIS (Bureau of Geographic Information), MassGIS Data: Surficial Geology. <https://docs.digital.mass.gov/dataset/massgis-data-surficial-geology>

7 U.S. Geological Survey, "Ground Water Atlas of the United States: Segment 12." 1995.

8 MA Executive Office of Energy and Environmental Affairs (EEA), Data Portal: Well Drilling. [https://eeaonline.eea.state.ma.us/Portal/#!/search/well\\_drilling](https://eeaonline.eea.state.ma.us/Portal/#!/search/well_drilling)

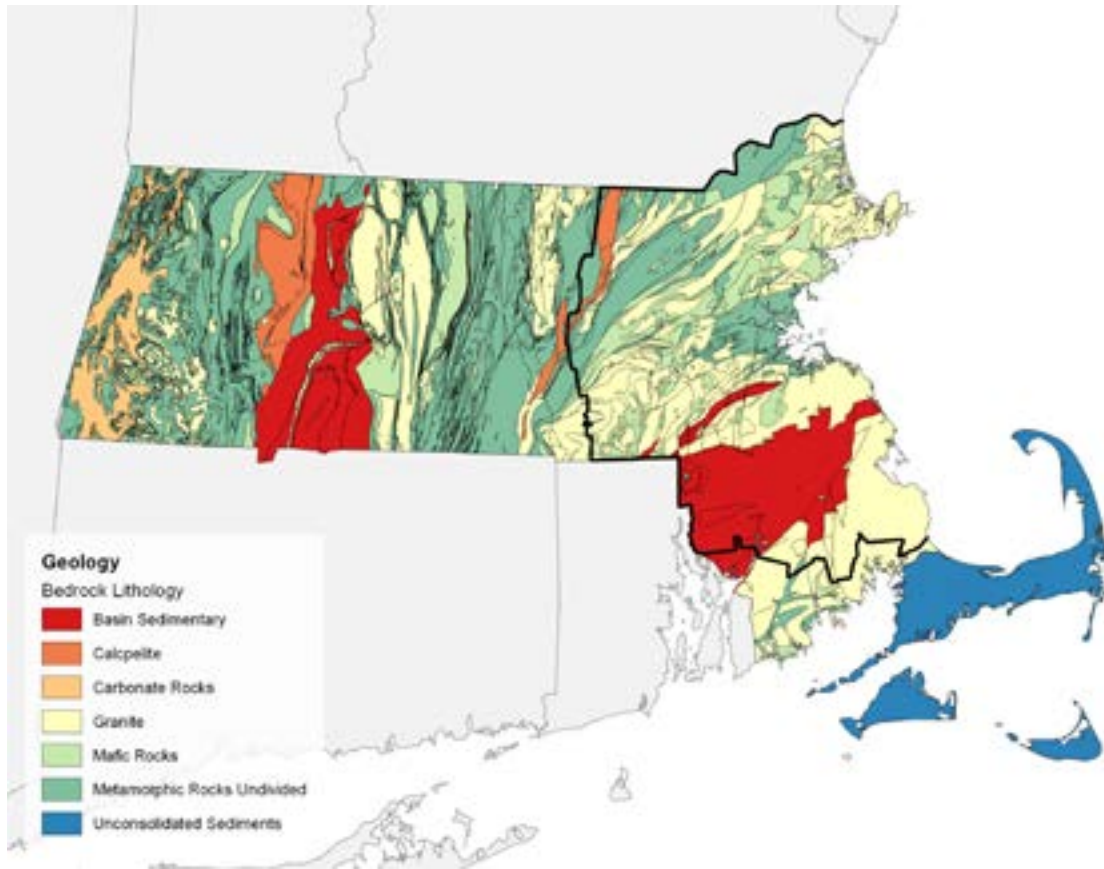

Figure II-4: Bedrock lithology in Massachusetts (source: MassGIS)

## Bedrock Lithology

Total Area by Geology Type

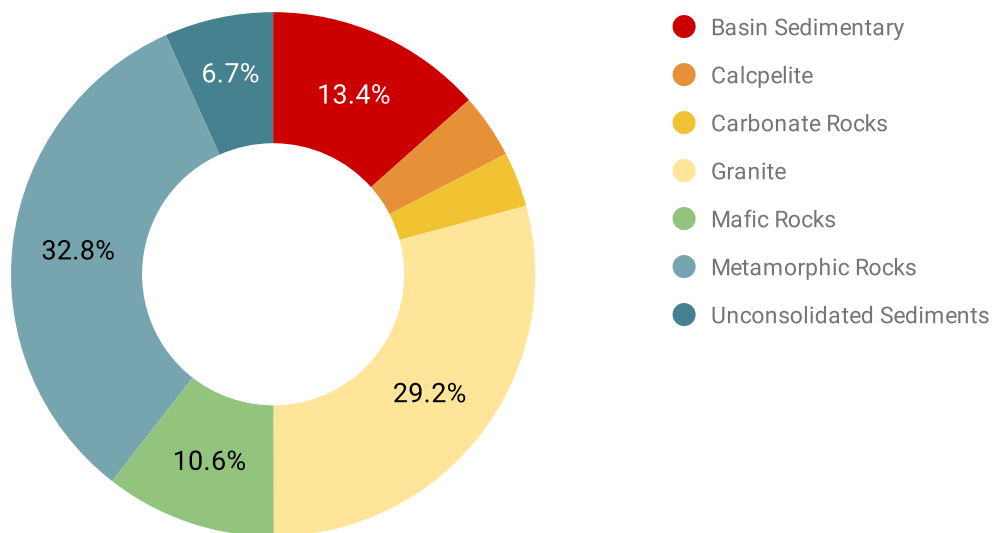

Figure II-5: Bedrock lithology by total surface area (source: MassGIS, BuroHappold Analysis)

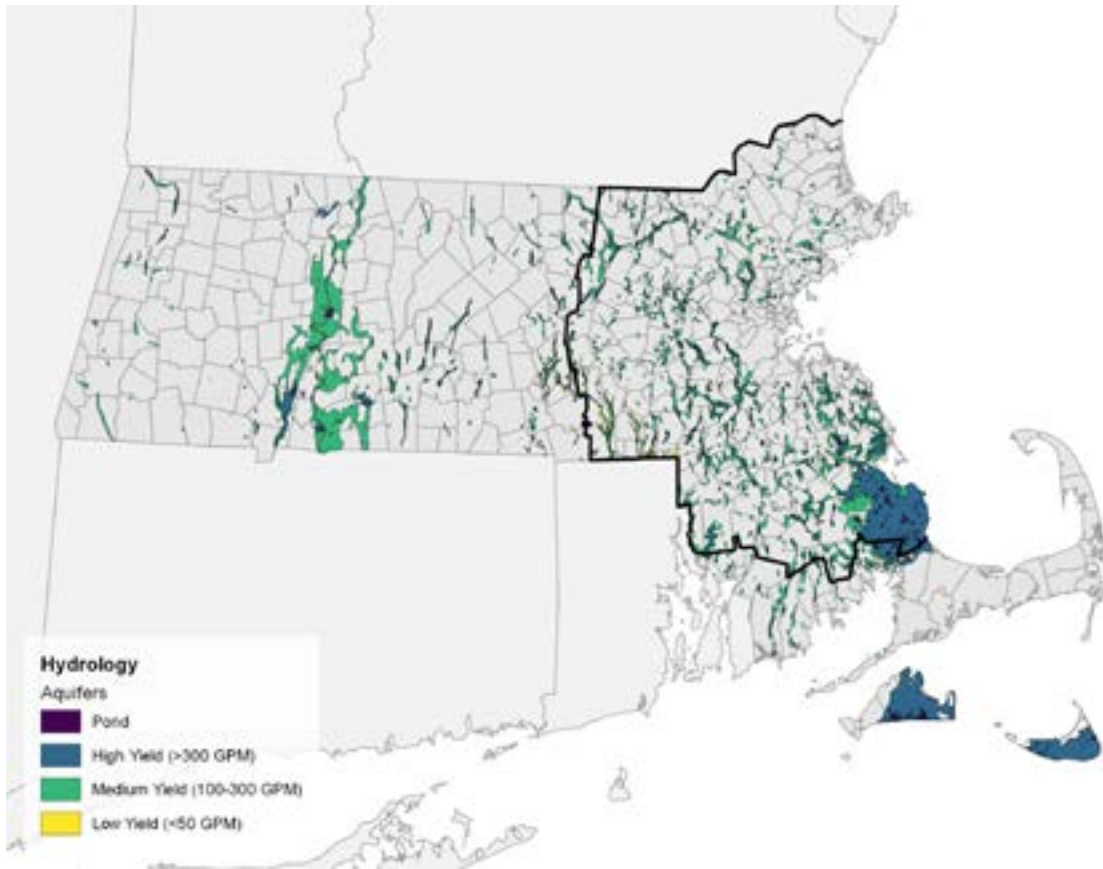

Figure II-6: Aquifers in Massachusetts (source: MassGIS)

of groundwater may also enhance the capacity of GCHP systems by improving the thermal conductivity of sediment and bedrock layers.

The feasibility of GWHP systems is generally determined by hydrogeological testing, water sampling, and the consultation of existing well log data for the site in question. In the testing phase, parameters including groundwater yield, direction of flow, and groundwater temperature, must be evaluated to determine system capacity. Static water level, permitted drawdown, and groundwater quality must be considered when selecting and sizing wells and well pumps. Many of these parameters are directly influenced by the type, thickness, permeability, and gradient of aquifers underlying the site.

Aquifers are classified as either confined or unconfined based on the surrounding rock or soil. Unconfined aquifers, also referred to as “water table” aquifers, are typically located close to the

earth’s surface and are bound by an impermeable bottom layer. When wells are drilled into unconfined aquifers, the water level remains unchanged, because groundwater pressure is the same as atmospheric pressure. This causes the water level and water production rate to decrease as the pumping rate increases.

Confined aquifers capture groundwater between two layers of impermeable materials (e.g., clay, fine grained soil, or consolidated rocks). When wells are drilled in confined aquifers, the water level rises because the groundwater pressure is much higher than atmospheric pressure. This results in relatively stable production over a range of pumping rates. It should be noted that, for a given pumping rate, confined aquifers have a much larger cone of depression (i.e., the depression of water levels or pressure in unconfined and confined aquifers, respectively) than unconfined aquifers, which requires larger spacing between wells.<sup>9</sup>

<sup>9</sup> American Society of Heating, Refrigerating and Air-Conditioning Engineers, “Geothermal Heating and Cooling: Design of Ground-Source Heat Pump Systems (GSHP).” 2014.



Vertical open GWHP systems consist of production and injection wells, which extract and re-inject groundwater, respectively. Extracted groundwater from the production well is circulated through the system and discharged through one or more injection wells.

Vertical open GWHP systems require high yield aquifers (i.e., aquifers where groundwater can be extracted without a significant decline in the water table) to ensure a sufficient flow rate for heat exchange and avoid issues caused by a severe aquifer drawdown (e.g., lower water levels in adjacent water bodies).

Conversely, Standing Column Well (SCW) systems rely on groundwater trapped inside unfractured rock, and do not require high yield aquifers.<sup>10</sup> These systems are preferred as an alternative to vertical open GWHP and GCHP systems for sites where the depth to bedrock is less than 100 feet. GWHP systems are not suitable if the groundwater has high levels of suspended sediments, minerals, and organic or inorganic contaminants that cause biofouling and corrosion in well equipment.

### 1.3 Surface Water

Surface water refers to any open body of water that is exposed to the atmosphere, including still water bodies such as lakes, ponds, and reservoirs, and moving water bodies such as streams, rivers, and canals. Surface water is the primary thermal source of SWHP systems, and the thermal capacity of those systems varies based on the flow, surface area, and depth of the water body used.

In many cases, those factors, combined with solar irradiation, create thermal stratification: the development of discrete layers of water temperatures at different depths resulting from the effect of temperature on water density. This provides the relatively consistent ambient temperatures required for a GSHP system.

Utilizing surface water, especially moving water, can reduce the costs and difficulties of system installation. However, because the GeoMicroDistrict system was constrained to the right of the way of the street, SWHP were not considered as part of the conventional design. Where possible, a SWHP could be added to an existing GeoMicroDistrict.

Before selecting and sizing SWHP systems, it is important to survey the seasonal temperature profiles to understand natural thermal patterns in water bodies. Further, it is critical to assess the potential short- and long-term impacts of SWHP systems on lake or riverine ecology as part of the initial testing phase. Federal, State, and local regulations should be reviewed early in the design process to ensure that SWHP systems are permitted in the locations under consideration.

#### 1.3.1 Lakes and Ponds

Unlike ground and groundwater, which have relatively consistent temperatures throughout the year, the temperature of lakes and ponds may vary based on heat transfer, water or groundwater flow, and mixing mechanisms (e.g., water motion that results in mixing). Heat transfer is primarily the result of solar irradiation, although sediment heat transfer (i.e., heat transfer from the surrounding ground) may also influence water temperature.

Typical mixing mechanisms include surface winds, internal waves, and the rate of inflow and outflow. In more shallow bodies of water (i.e., those less than 40 feet in depth), mixing may disrupt the naturally occurring temperature-density gradients created by thermal stratification.<sup>11</sup> In cases where stratification is disrupted throughout the year, SWHP are generally not feasible.

In lakes and ponds deeper than 40 feet, thermal stratification often exists throughout the year, and the bottom layer of water will maintain a relatively consistent temperature throughout the winter and summer.<sup>12</sup>

However, in the Northeast, SWHP systems in lakes and ponds are generally used for cooling. If SWHP systems are used for heating, water temperatures must be at least 42°F (6°C) for open systems, and 32°F (0°C) for closed systems to avoid the formation of frost within the system's components. Open SWHP systems are more susceptible to frost because they draw in surface water directly.<sup>13</sup>

#### 1.3.2 Rivers and Streams

River and streams are typically less stratified than ponds and lakes, and water temperatures are more likely to fluctuate with the temperature of

<sup>10</sup> A standing column well (SCW) is a type of open-loop GWHP system that uses a single well for both the production and injection of groundwater, reducing the amount of area needed to install the system. See Appendix A of this Study for additional information.

<sup>11</sup> American Society of Heating, Refrigerating and Air-Conditioning Engineers, "Geothermal Heating and Cooling: Design of Ground-Source Heat Pump Systems (GSHP)," 2014.

<sup>12</sup> Ibid.

<sup>13</sup> Ibid. See Appendix A for a description of open and closed SWHP systems.

the ambient air.<sup>14</sup> Similar to lakes and ponds, the temperature of rivers and streams is affected by atmospheric conditions, flow velocity, groundwater inflows, and heat transfer to and from the river or stream bed.

Depending on suitable water quality, open SWHP systems are feasible for rivers and streams with a winter water temperature greater than 42°F (6°C), whereas closed systems are suitable with winter water temperatures greater than 32°F (0°C), or wherever the water body does not freeze.

Closed systems are also preferable if water contains high volumes of contaminants or suspended solids, which could cause fouling and corrosion in open loop systems. Closed systems are less likely to disrupt the ecology of the water body, as they do not interact with it directly.

## 2 Land Use Patterns

Existing land use, ownership, and regulatory constraints often factors in evaluating the feasibility of certain GSHP systems. Areas characterized by larger lot sizes and lower densities generally have more space available for GSHP installation. In these cases, thermal source characteristics and system cost are the primary drivers of design.

In more dense areas with smaller lot sizes, space constraints may affect GSHP system capacity if sufficient area is not available to provide the required clearances between wells for GWHP systems or to allow the number of boreholes or trenches needed for a GCHP system to meet heating and cooling loads. Moreover, higher density areas will require more heating and cooling for a given unit of land, further increasing the required system capacity.

Multi-tenant uses create further complexity, as the party responsible for installing and maintaining a GSHP system (e.g., the property owner) may not be its primary user (e.g., tenants who use GSHP heating and cooling). Higher density areas, however,

generally have higher load diversity and are often located closer to more diverse sources of waste heat, and other potential thermal sources and sinks.

### 2.1 Land Use in Massachusetts

A majority of developed land in Massachusetts is for residential uses. Low density residential use (i.e., one to two households per acre) is the largest single land use segment at 28 percent of developed land area, followed by medium density residential (i.e., two to four households per acre) and high density residential (i.e., more than four households per acre), which are each approximately 20 percent.<sup>15</sup>

Non-residential land uses are relatively equal, each constituting approximately seven percent of developed land area. In terms of total land area, the dominant land use types are forest and wetlands, which represent approximately 56 percent and 15 percent of Massachusetts land area, respectively. The greatest concentration of forested land is found in Western Massachusetts, whereas larger wetland areas are found to the east near the Atlantic coast.<sup>16</sup>

The highest residential densities in the state are concentrated around the Boston Harbor, and the City of Springfield in Western Massachusetts.<sup>17</sup> Within the Greater Boston area, residential densities range from less than one to eight or more households per acre. Higher densities occur in cities such as Boston, Cambridge, and Somerville. A majority of residential properties in Greater Boston are one- and two-family homes, which comprise more than 90 percent of properties in the area.

A majority of non-residential properties in Greater Boston are small retail stores and general office buildings.<sup>18</sup> Although these values are an aggregate representation of the area, they indicate a potential lack of land use diversity along any given block or street segment—and corresponding lack of diverse heating and cooling loads—which may limit the capacity of individual street-scale GSHP installation locations.

<sup>14</sup> Oklahoma State University, "Surface water heat pump systems." 2016.

<sup>15</sup> MassGIS (Bureau of Geographic Information), MassGIS Data: Land Use (2005). <https://docs.digital.mass.gov/dataset/massgis-data-land-use-2005>

<sup>16</sup> Ibid.

<sup>17</sup> U.S. Census Bureau, 2013-2017 American Community Survey 5-Year Estimates, S2504 Physical Housing Characteristics for Occupied Housing Units.

<sup>18</sup> MassGIS (Bureau of Geographic Information), MassGIS Data: Standardized Assessors' Parcels. <https://docs.digital.mass.gov/dataset/massgis-data-standardized-assessors-parcels>

## Land Use in Massachusetts

Total Area by Land Use Type

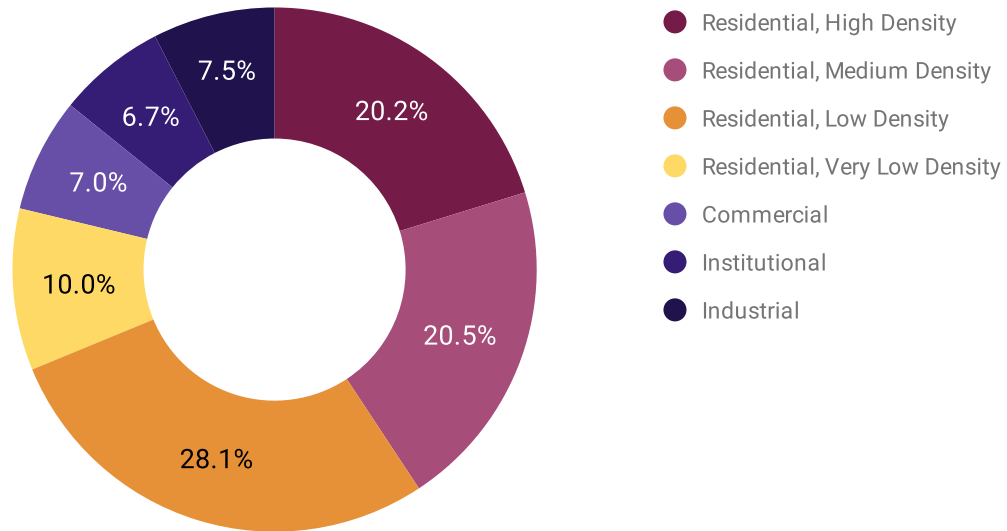

Figure II-7: Land use by total area; excludes open space (source: MassGIS, BuroHappold Analysis)

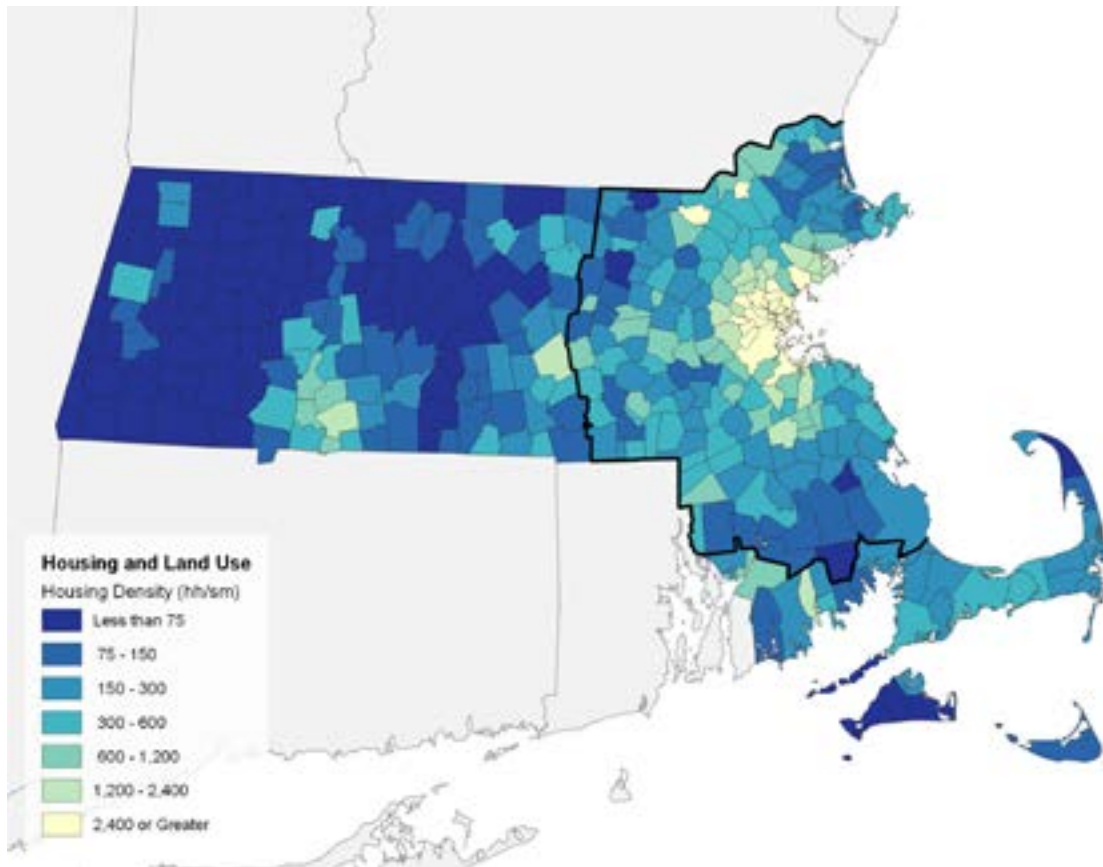

Figure II-8: Housing density in Massachusetts (source: U.S. Census, BuroHappold Analysis)

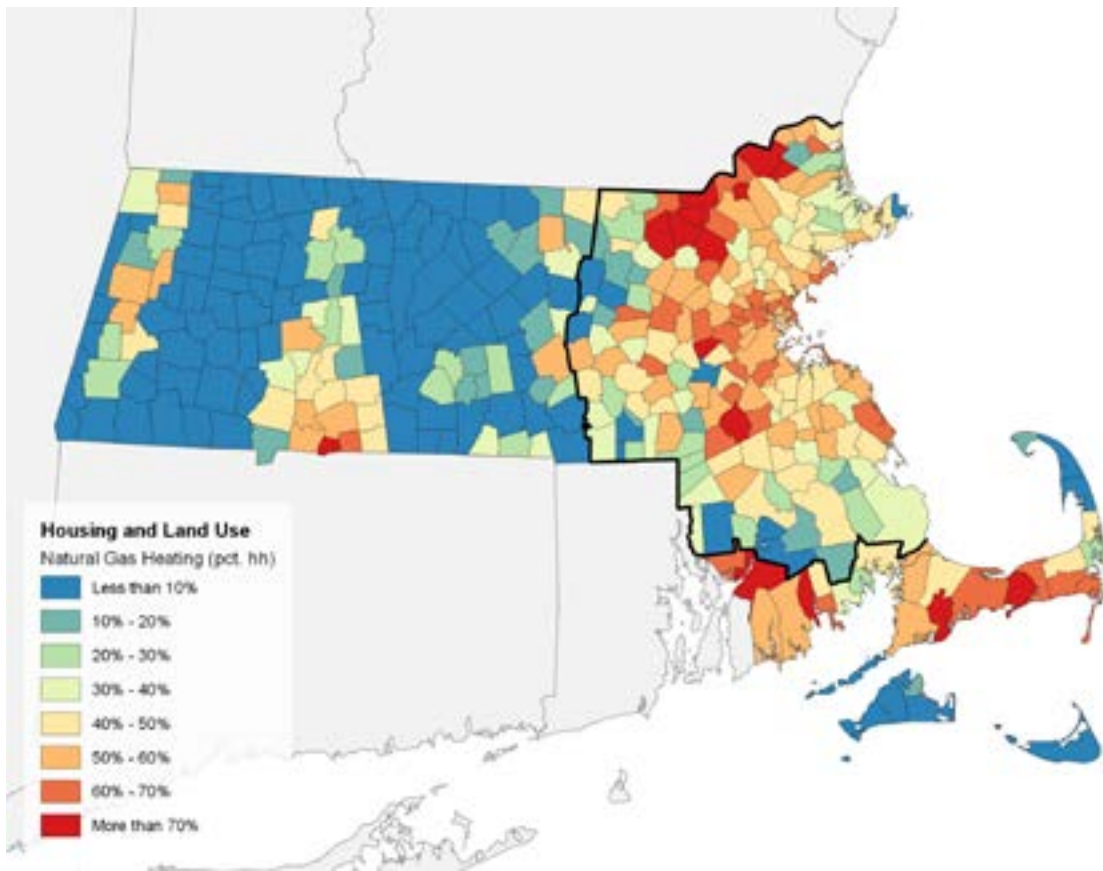

Figure II-9: Natural gas heating in Massachusetts (source: U.S. Census, BuroHappold Analysis)

## 2.2 Property and Street Characteristics

For the purposes of this Study, the analysis of certain property characteristics such as average lot and building size were limited to Greater Boston, because that is where most gas infrastructure is currently located.

Within Greater Boston, one- and two-family homes are approximately 2,000 to 2,600 square feet in total floor area and typically located on 5,000 to 10,000 square-foot lots. Larger residential properties range in size from 3,000 to 20,000 square feet in total floor area and are typically located on 5,000 to 25,000 square-foot lots.

Small retail and general office buildings in Greater Boston are approximately 5,000 square feet in total floor area and are typically located on lots of 10,000

to 30,000 square feet. These values were used to develop the Prototype Street Segments described in Chapter III of this Study.

The average right-of-way (ROW) width for local roads throughout Massachusetts is 40 feet, with an average roadway surface width of 16 feet.<sup>19</sup> However, the use of non-roadway ROW for parking, sidewalks, or planting strips varies across and within local jurisdictions.

Within the more densely populated areas of Greater Boston, street parking lanes and sidewalks were located within the ROW, limiting the size of the roadway. In less dense, primarily residential areas, sidewalks were typically located outside of the ROW on private property and street parking was not provided. In all cases, lot dimensions were typically 50 to 100 feet in length along the ROW and 100 to 200 feet deep.

<sup>19</sup> Massachusetts Department of Transportation, Road Inventory 2017. [https://geo-massdot.opendata.arcgis.com/datasets/ef9192ecac9d44deac4a6b8711868c21\\_0](https://geo-massdot.opendata.arcgis.com/datasets/ef9192ecac9d44deac4a6b8711868c21_0)

Underground ROW infrastructure typically consists of gas lines, telecom and data cables, and either a combined sewer system or separated domestic sewer and stormwater systems. Electricity may be distributed through either underground or overhead power lines.

### 3 Building Energy

Building energy consumption patterns are generally consistent among similar buildings (i.e., those with similar uses and occupancies) within a given climate. For example, approximately 60 percent of annual energy consumption for residential buildings in the Northeast is for space heating. Moreover, the amount of energy consumed is generally the same for similar buildings on a square-foot basis.

This metric of measurement is referred to as “energy use intensity” (EUI) and is calculated as the unit of energy per unit of gross floor area. Heating, cooling, and domestic hot water (DHW) energy consumption patterns and EUI values for five key building typologies were used in this Study to estimate heating and cooling loads for existing buildings and the GSHP system capacities required to meet those loads.

#### 3.1 Energy Efficiency

A large portion of existing buildings in Massachusetts were constructed in the early 20th century or before. Because of their age, many of these buildings have relatively inefficient mechanical systems and are poorly insulated. This results in higher heating and cooling loads, and therefore higher energy consumption and larger heating and cooling equipment.

A GSHP system for one of these buildings would occupy a greater area, and require a larger heat pump, than one for a more efficient building of comparable size and use. Moreover, the construction work within the building required to install a new GSHP system creates an opportunity for energy efficiency retrofits.

To evaluate the impact of relatively simple energy efficiency retrofits on the size, cost, and ability of GSHP systems to meet heating and cooling loads, the following moderate energy efficiency measures

were applied to the baseline building energy consumption estimates described at the beginning of this Section:

- Upgrade existing insulation in exterior walls and the roof. Assumes existing R-15 wall insulation is upgraded to R-20, and existing R-20 roof insulation is upgraded to R-40.
- Seal exterior openings throughout the building. Assumes air sealing reduces air infiltration by 0.2 to 0.4 air changes per hour (ACH).
- Apply a white or reflective roof coating. Assumes a five to eight percent reduction in cooling energy consumption.

#### 3.2 Thermal Balance

It is critical that GSHP systems maintain a balance between the heat extracted and rejected into the ground or other thermal source over the course of the year. For example, an abundance of heat rejected into the ground during the summer, when cooling is needed, must be extracted during the winter to maintain the ground’s stable temperatures.

Without this balancing, the ground may become gradually warmer, reducing the operating efficiency of the GSHP system and altering the long-term temperature and physical properties of the ground, groundwater, or surface water body used as a thermal source. This “thermal degradation” also occurs in cases where more heat is extracted (i.e., more heating is provided) than is rejected, leading to the gradual cooling of the ground or other thermal source.

A GSHP system that is meant to meet 100 percent of a building’s heating and cooling loads must have sufficient capacity to perform during both extreme winter and summer days (i.e., peak heating and cooling loads). However, heating and cooling loads are rarely identical and supplemental heating or cooling is one potential option to mitigate thermal degradation and ensure that peak loads can be met. In Massachusetts, heating demand is generally higher than cooling demand for most building types; for residential buildings, heating is often more than 60 percent of total energy consumption.

Because of this, a majority of existing GSHP systems are typically installed with supplemental heating of some form, including solar thermal or other

## Baseline End Use Energy Consumption

Percent Annual Consumption by Typology and End Use

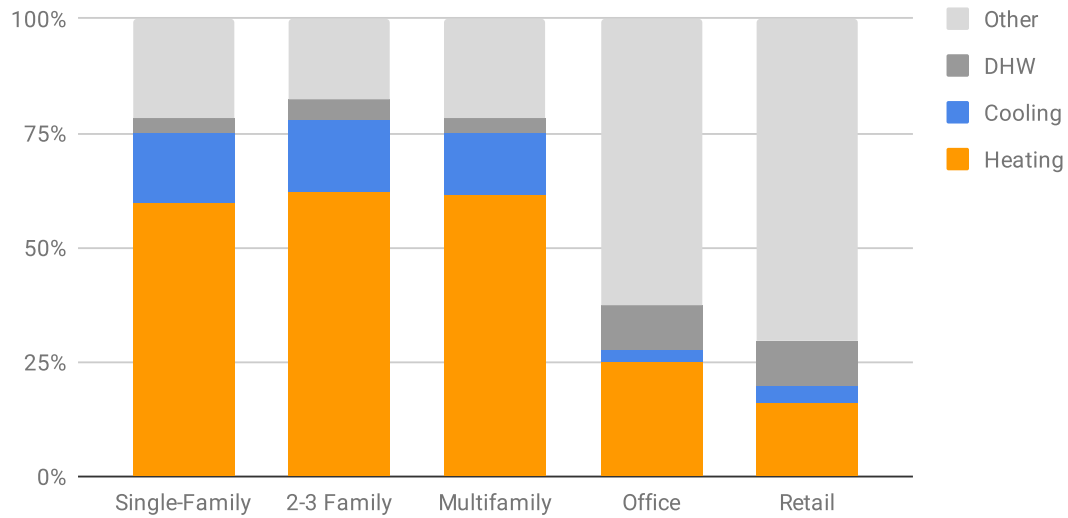

Figure II-10: Baseline end use energy consumption patterns for key building typologies

## Baseline Annual Energy Consumption

Energy Use Intensity (EUI) by Typology

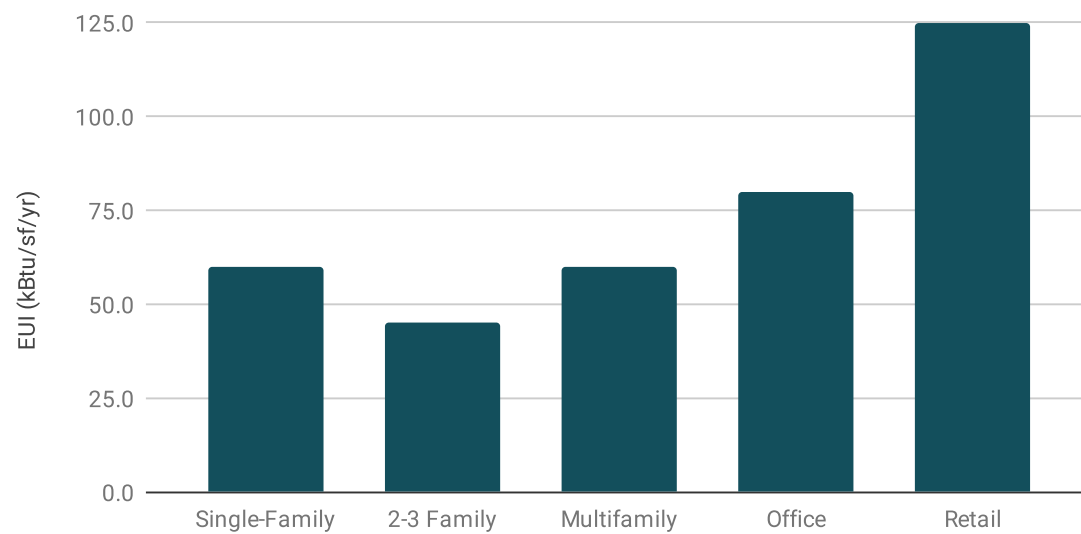

Figure II-11: Estimated baseline energy use intensity for key building typologies

## Energy Efficiency End Use Energy Consumption

Percent Annual Consumption by Typology and End Use

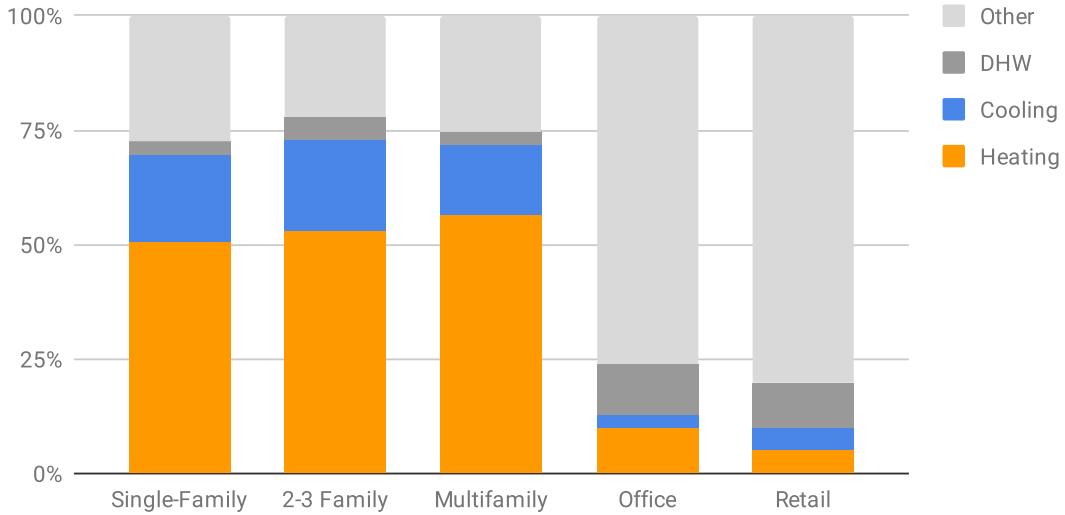

Figure II-12: Energy efficiency end use energy consumption patterns for key building typologies

## Energy Efficiency Annual Energy Consumption

Energy Use Intensity (EUI) by Typology

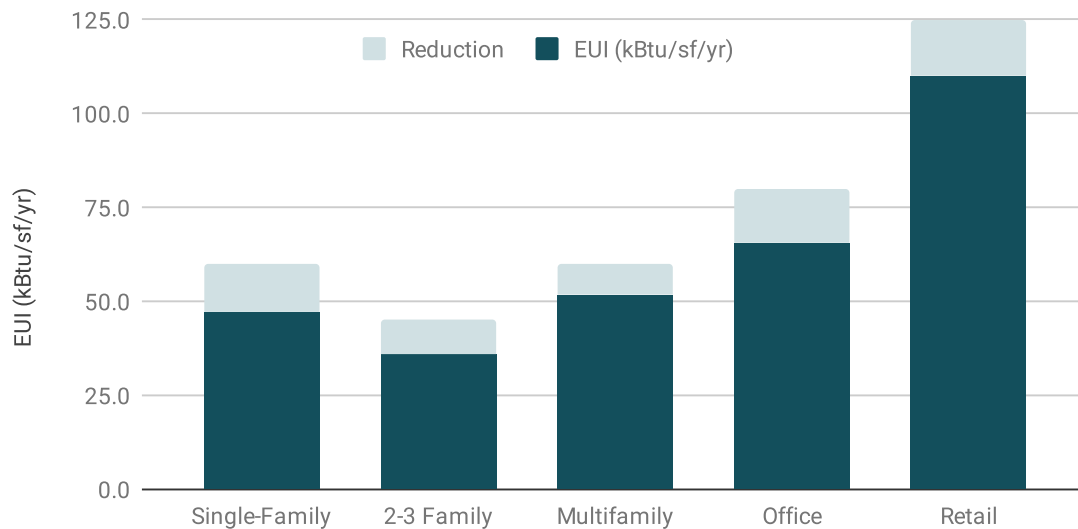

Figure II-13: Estimated reduction in baseline energy use intensity for key building typologies

## Peak Day Hourly Heating Demand

Residential and Commercial Uses

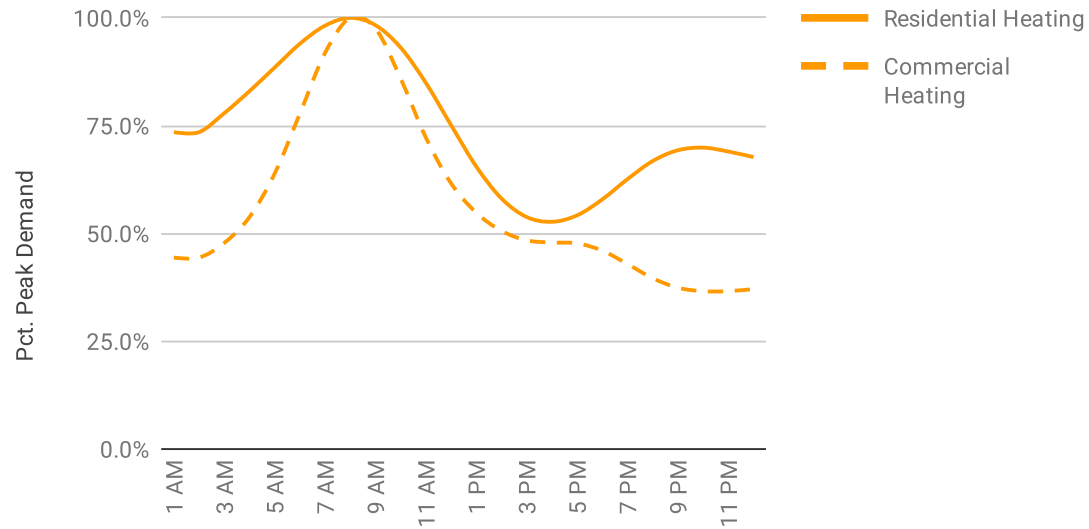

Figure II-14: Comparison of residential and commercial peak heating demand patterns

## Peak Day Hourly Cooling Demand

Residential and Commercial Uses

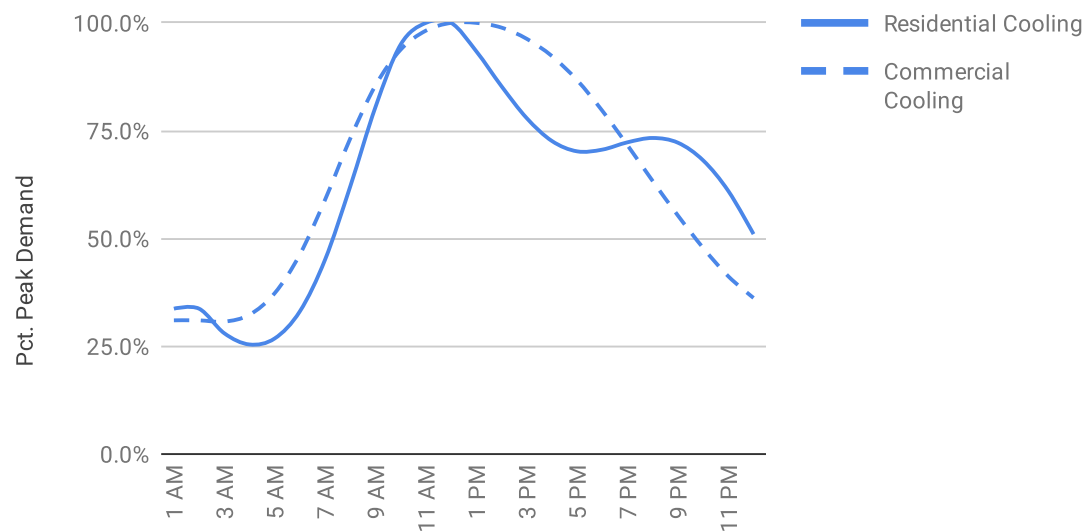

Figure II-15: Comparison of residential and commercial peak cooling demand patterns



renewable sources.<sup>20</sup> It should be noted that the need to manage, or balance, the thermal system over time will change as the climate changes, with Massachusetts likely to undergo a shift from a heating dominant to a cooling dominant climate by 2070.<sup>21</sup>

### 3.3 Coincident Demand

Street-scale and larger, interconnected GSHP systems may serve multiple buildings with diverse uses and occupancies. This increases the diversity of heating and cooling loads and may help mitigate the aforementioned issues with thermal balance.

Further, interconnected GSHP systems may be sized to meet coincident—rather than individual building—peak heating and cooling demand,

reducing installation and operating costs. Increased diversity also increases the utilization and efficiency of a GSHP system, as it can help “smooth” demand patterns and take advantage of coincident heating and cooling loads.

Additional buildings can also be added to an interconnected GSHP system to strategically incorporate heating or cooling loads that serve a balancing function. For example, in the Northeast, building types with higher than average cooling loads (e.g., ice hockey rinks or grocery stores) could help balance the higher heating loads associated with residential buildings. This creates a key role for utility management of the thermal network over space and time.

---

20 MassCEC, Ground Source Heat Pump Program: Residential & Small-Scale Project Database; updated September 2018. <https://www.masscec.com/ground-source-heat-pump-installer-resources>

21 City of Cambridge, The Port Preparedness Plan, Appendix 2: Energy Resilience for the Port, May 2019.

# Chapter III: Engineering Feasibility

## 1 Prototypical Street Segments

The engineering feasibility and capacity of GSHP systems depends on various site-specific factors, including the properties of available thermal sources and the heating and cooling needs of connected buildings. Because the geographic scope of this Study is the entirety of Massachusetts, a number of prototypical conditions were created to represent common building and land use characteristics across the state. These conditions were based on the analyses described in Chapters I and II of this Study.

Four prototypical street segments (PSS) were developed to represent these conditions at the level of a single street—the starting point of a scalable GeoMicrodistrict:

1. Low density residential
2. Medium density residential
3. Medium density mixed-use
4. High density mixed-use

It should be noted that certain conditions, specifically very low density residential and ultra-high density urban areas, were not considered as part of this analysis. Very low density residential areas are more suitable for individual GSHP installations because of the cost of maintaining such a large distribution network with relatively little capacity. Ultra-high density urban areas are unlikely to have sufficient below street space to install a GSHP system with the capacity to meet heating and cooling loads for high rise multifamily or commercial buildings.

Each PSS is composed of two contiguous lines of residential or commercial properties on either side of a 40-foot wide, 500-foot long public ROW with a two-foot wide utility corridor. Each PSS terminates at one end in a corner condition; the opposite side is undefined. Mixed-use PSS are characterized by either commercial office or retail uses at the corner, whereas residential typologies consist of the same building typology throughout.

Lot depths range from 100 to 150 feet and lot widths range from 50 to 100 feet, depending on the land use and whether the property is on a corner.

Building heights range from one to eight stories, and floor areas range from 1,500 to 72,000 square feet for single-family homes and commercial office buildings, respectively.

### 1.1 Heating and Cooling Loads

As mentioned in Chapter II, Section 3 of this Study, interconnected GSHP systems such as a GeoMicroDistricts benefit from overall lower thermal demand because of the overlap between simultaneous heating and cooling loads. Coincident thermal demand was calculated for each PSS based on the hourly heating and cooling demand profiles for their respective building typologies.

Annual consumption is simply the aggregation of monthly heating and cooling consumption for each building within a PSS. These outputs were then used to size and optimize GSHP systems for each PSS and determine the extent to which heating and cooling loads could be met.<sup>1</sup>

## 2 GSHP System Selection

Multiple factors must be considered prior to selecting a suitable GSHP system, including building heating and cooling requirements, available land area, and the geological and hydrogeological characteristics of available thermal sources. Further, there are numerous environmental regulations for systems that may affect existing groundwater and surface water bodies, limiting the feasibility of GWHP and SWHP systems.

Many local jurisdictions enforce their own environmental requirements in addition to state and federal regulations. This Study references requirements and guidelines established by the Massachusetts Department of Environmental Protection (MassDEP); it should not be taken as a comprehensive account of the requirements applicable to a GSHP project.

MassDEP guidelines for GSHP wells provide installation, design, and site testing requirements for open and closed-loop GSHP systems in compliance

<sup>1</sup> The demand and consumption values shown assume that PSS buildings have undergone the moderate energy efficiency retrofits described in Chapter III, Section 3.1 of this Study.

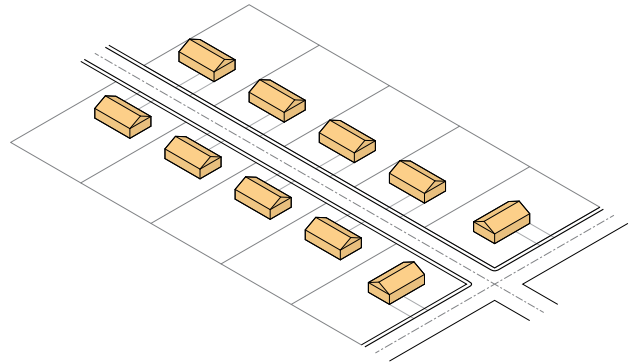
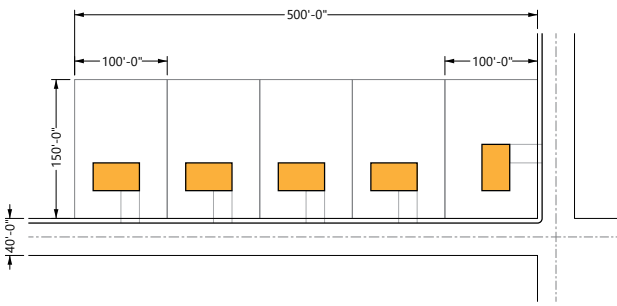

Figure III-1: Low density residential PSS

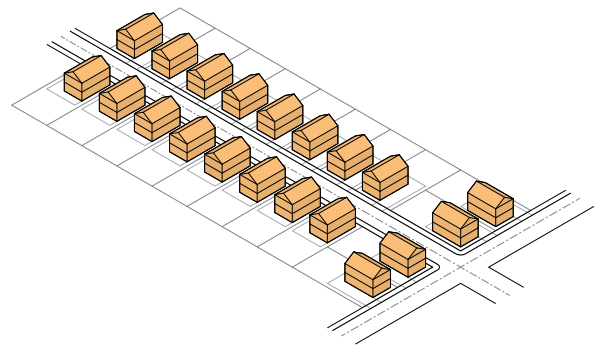
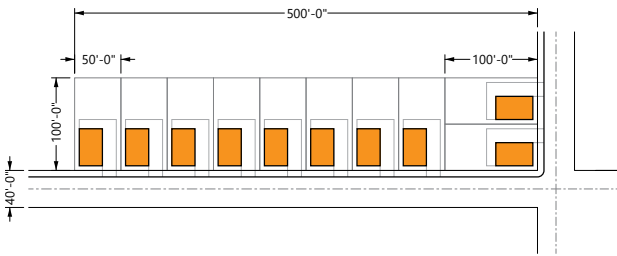

Figure III-2: Medium density residential PSS

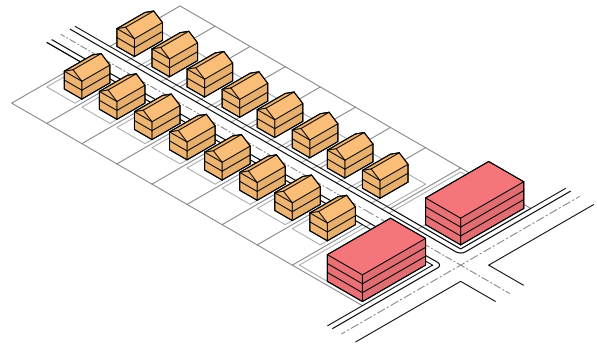
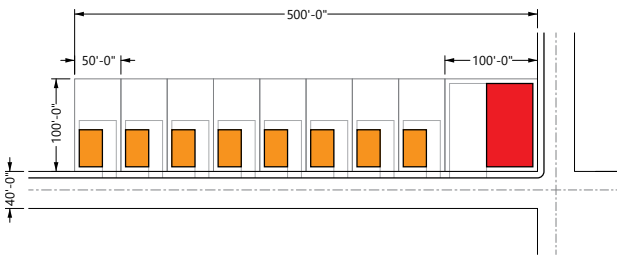

Figure III-3: Medium density mixed-use PSS

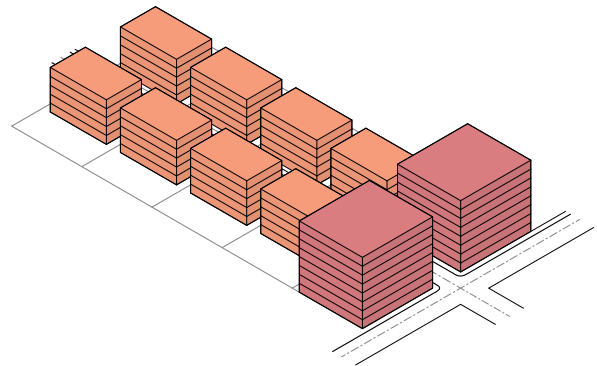
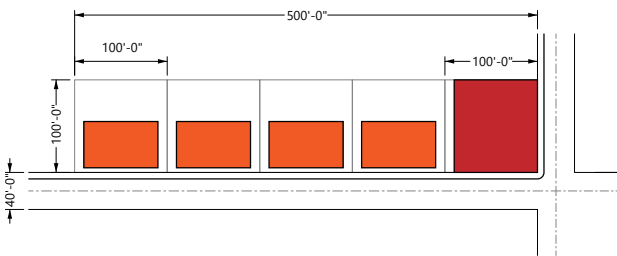

Figure III-4: High density mixed-use PSS

Table III-1: PSS composition and characteristics

Prototypical Street Segment	Building Typology	Number of Buildings	Floor Area (square feet)	Height (stories)
Low density residential	Single-family residential	10	1,500	1
Medium density residential	2-3 family residential	20	3,000	3
Medium density mixed-use	2-3 family residential	16	3,000	3
	Commercial retail	2	13,500	3
High density mixed-use	Multifamily residential	8	20,000	5
	Commercial retail	2	72,000	8

Table III-2: PSS coincident thermal demand and annual thermal energy consumption

Prototypical Street Segment	Coincident Demand (tons)		Annual Consumption (MBtu/year)	
	Heating	Cooling	Heating	Cooling
Low density residential	20	15	286	67
Medium density residential	121	138	1,746	594
Medium density mixed-use	57	133	821	1,153
High density mixed-use	297	470	4,305	3,946

with the Code of Massachusetts Regulations (CMR) and U.S. Environmental Protection Agency (EPA) regulations.<sup>2</sup>

The guidelines contain prescriptive requirements that enable GSHP installations to circumvent the underground injection control (UIC) permitting process, and apply to any GSHP system that provides heating or cooling with relatively low ambient ground temperatures (i.e., 90°F (32°C) or less).

The guidelines include the following key provisions:

- Open-loop GSHP wells that do not also serve as a potable water supply sources should be located at least 25 feet from private potable water supply wells and potential sources of contamination (e.g., septic tanks or fields, lagoons, livestock pens, oil or hazardous materials storage tanks).
- Closed-loop GSHP wells should be located at least 25 feet from potential contamination sources; and at least 50 feet from private potable water supply wells.
- Neither an open-loop discharge well nor a closed-loop well should be located within a 100 to 400 foot MassDEP-approved protective radius of a public water supply well.
- Closed-loop wells should be located at least 10 feet from surface water bodies.
- Open- and closed-loop wells should be located at least 10 feet from potable water and sewer lines.
- No borehole or well can extend within 10 feet of a property boundary without the expressed written consent of the owner.

<sup>2</sup> Massachusetts Department of Environmental Protection and Bureau of Resource Protection, "Guidelines for Ground Source Heat Pump Wells," 2013.

Open-loop GSHP wells that also serve as a potable water supply well (i.e., a dual use well) must be installed in conformance with MassDEP's Private Well Guidelines and MassDEP's Guidelines and Policies for Public Water Systems, where applicable.<sup>3</sup> However, it is unlikely that a GeoMicroDistrict would include such a configuration.

## 2.1 Ground Coupled Heat Pumps

Horizontal loop ground coupled heat pump (GCHP) systems are generally suitable for low density residential areas with relatively low heating and cooling demands. The additional capacity provided by a horizontal coil GCHP system may provide sufficient capacity for medium density residential and mixed-use areas with saturated soils (i.e., higher thermal conductivity).

Vertical GCHP systems are suitable for most areas, although they provide the greatest capacity in areas with relatively shallow granite or metamorphic bedrock. However, areas with thick glacial deposits may pose challenges, as it may not be cost-effective to drill in those locations.<sup>4</sup>

Vertical GCHP systems are classified as Class V injection wells by the EPA and a permit is required to place it within 50 feet between boreholes and private drinking water wells. It should also be noted that propylene glycol and ethanol are the only antifreeze additives permitted for closed-loop GCHP systems in Massachusetts.<sup>5</sup>

The proposed GeoMicroDistrict design uses water with no additives, as case studies in regions with similar or even greater annual temperature ranges have omitted antifreeze additives with no problems.<sup>6</sup>

## 2.2 Ground Water Heat Pumps

The feasibility of installing a ground water heat pump (GWHP) system is greatly limited by well spacing, pumping costs, and environmental regulations. The well spacing required to avoid

thermal interferences can range from 50 to 250 feet, depending on the system configuration and aquifer yield, which varies greatly across Massachusetts.

Further, the costs required for pumping are typically prohibitive in locations where the groundwater depth is greater than 100 feet.<sup>7</sup> Although SCW systems require less pumping energy, the cost of steel casing for the exterior borehole may become prohibitive in areas where distance to bedrock is greater than 100 feet.

Per MassDEP guidelines, GWHP wells should maintain a distance of at least 10 feet from potable water and sewer lines, and 25 feet from private potable water supply wells and potential sources of contamination.<sup>8</sup> It should be noted that local environmental regulations may prohibit the installation of GWHP systems altogether.

These guidelines, in addition to the aforementioned spacing needs, would likely add significant time and expense to GWHP installations within an existing ROW. Because of this, GWHP systems were excluded from more detailed engineering and economic analyses.

However, this should not be taken to imply that independent GWHP systems are not feasible on private property if the necessary permits are granted. Moreover, there may be opportunities to integrate existing GWHP systems into an expanding GeoMicroDistrict.

## 2.3 Surface Water Heat Pumps

The feasibility of a Surface Water Heat Pump (SWHP) system depends largely on local hydrology, water temperature, and environmental regulations. Given Massachusetts's climate, closed-loop SWHP systems are generally more suitable than open-loop for heating and cooling applications because they can perform below freezing temperatures on peak winter days. As noted in the previous sections, in cases where an antifreeze additive is used, only propylene glycol and ethanol are allowed for use in Massachusetts.<sup>9</sup>

3 Massachusetts Department of Environmental Protection, "Private Well Guidelines," 2008.

4 Massachusetts Department of Environmental Protection and Bureau of Resource Protection, "Guidelines for Ground Source Heat Pump Wells," 2013.

5 Ibid.

6 See the Colorado Mesa University in Boulder, CO and the Ectogrid in Lund, Sweden.

7 NYC Mayor's Office of Sustainability, "Geothermal Heat Pump Manual," 2013.

8 Massachusetts Department of Environmental Protection and Bureau of Resource Protection, "Guidelines for Ground Source Heat Pump Wells," 2013.

9 Ibid.

SWHP performance is determined by the thermal stratification of an existing water body, which may vary with season, depth, and water flow.<sup>10</sup> Similar to GWHP systems, environmental regulations may prohibit the installation of SWHP systems, and a comprehensive site survey may be required to determine the ecological impact of a such systems.

Because it was not possible to reasonably estimate the capacity of a “typical” SWHP system within the scope of this Study, these systems were also excluded from more detailed engineering and economic analyses. However, closed-loop SWHP systems should be considered during the design of new waterfront developments and may be integrated into an adjacent GeoMicroDistrict should the opportunity arise.

### 3 GSHP System Design

Given the physical and regulatory constraints facing GWHP, and SWHP systems, this Study focused on GCHP for more detailed engineering and economic analysis. As mentioned previously in this Study, the capacity of a GCHP is determined by the composition of soil and rocks, depth to bedrock, seasonal ground temperatures, and numerous other factors.

Although this Study provides estimates for capacity based on typical conditions in Massachusetts, a geological survey and thermal testing should be conducted at the site prior to the design and implementation of a GCHP system. Professionals typically use specialized simulation software to evaluate the performance of various loop configurations and flow rates, using information from the aforementioned site studies to size and design the system.

#### 3.1 Modeling Approach

This Study uses Verein Deutscher Ingenieure (VDI) standards to estimate the amount of heat extracted and rejected into the ground for heating and cooling, respectively.<sup>11</sup> Heat abstraction rates for soil and bedrock types common in Massachusetts were used to calculate heat extracted or rejected

from the ground by the GCHP system. This value was based on the length of the GSHP loop (i.e., the piping network within the ground), which varied based on the system configuration and estimated coefficient of performance (COP).

The GCHP loop length for horizontal systems was calculated based on trench length and number of trenches, whereas the loop length for vertical systems was based on the borehole depth and number of boreholes. The number of trenches or boreholes was based on the minimum spacing required to avoid thermal interference issues, and the area available for installation (i.e., the utility ROW versus the full ROW).

Coefficient of performance (COP) expresses the ratio of heating or cooling energy output to the required energy input, including energy used to operate heat pumps and auxiliary equipment. In the context of this Study, the heating or cooling energy output is equal to the heat extracted or rejected ( $q$ ) from the GSHP loop. The energy input is equal to the electricity required to operate the GSHP system.

It should be noted that the energy input required to provide cooling (i.e., reject heat) is always greater than the energy needed to provide heating (i.e., to extract heat). This is partially because the system must reject excess heat from auxiliary equipment (i.e., compressors, fans), in addition to the heat from the building. As a result, COP values for heating ( $COP_h$ ) and cooling ( $COP_c$ ) are not identical for the same system.<sup>12</sup>

Heat pump manufacturers specify  $COP_h$  and  $COP_c$  values for individual GSHP units operating in open-loop and closed-loop configurations (i.e., GCHP systems). Based on 2019 ENERGY STAR® ratings for closed-loop GSHP units,  $COP_h$  ranges from 3.1 to 4.9, and  $COP_c$  ranges from 4.7 (EER 16.1) to 10.1 (EER 34.3).<sup>13</sup> In a district GSHP system, the individual efficiencies of multiple heat pumps may be combined to estimate seasonal COP values for the entire system.

This Study assumes an average  $COP_h$  of 5, and an average  $COP_c$  of 6 for all of the street-scale GSHP systems modeled. These values are slightly conservative and are meant to account for

<sup>10</sup> See Chapter II, Section 1.3 of this Study.

<sup>11</sup> VDI-Richtlinie 4640 is a set of technical guidelines developed by the Association of German Engineers for planning and designing GSHP systems. These guidelines provide specific heat abstraction rates for typical soil and rock types, simulated over 1,800 and 2,400 hours of operation.

<sup>12</sup> It should be noted that cooling COP is also referred to as “energy efficiency ratio” (EER).

<sup>13</sup> ENERGY STAR Most Efficient 2019 — Geothermal Heat Pumps. [https://www.energystar.gov/products/energy\\_star\\_most\\_efficient\\_2019/geothermal\\_heat\\_pumps](https://www.energystar.gov/products/energy_star_most_efficient_2019/geothermal_heat_pumps)

Table III-3: Specifications for GCHP systems modeled

System Parameter	Horizontal Loop	Horizontal Coil	Vertical
Dimensions	2 feet wide, 4 to 6 feet deep trenches	1 foot wide, 6 to 8 feet deep trenches	Borehole depth up to 500 feet
Piping configuration	Two linear pipes per trench	One overlapping coil (2 feet in diameter, 40 percent overlap) in standing position per trench	One U-tube pipe per borehole, connected by horizontal headers
Spacing	2 to 4 feet, edge to edge	10 to 15 feet, edge to edge	10 to 20 feet on center
Installation area	1 trench (utility ROW) 7 trenches (full ROW)	1 trench (utility ROW) 3 trenches (full ROW)	32 boreholes (utility ROW) 64 boreholes (full ROW)

performance variations due to operating conditions, ground temperatures, and building distribution systems.

The peak heating capacity ( $Q_h$ ) and cooling capacity ( $Q_c$ ) of a given GCHP system was calculated based on the average heating and cooling COP, and the heat extracted or rejected ( $q$ ) by a GSHP loop.<sup>14</sup>

$$\text{Equation 1: } Q_h = q \times \text{COP}_h / (\text{COP}_h - 1)$$

$$\text{Equation 2: } Q_c = q \times \text{COP}_c / (\text{COP}_c + 1) = q \times \text{EER} / (\text{EER} + 3.412)$$

The annual heating and cooling energy provided a given GCHP systems was calculated based on peak demand met and annual operating hours for heating and cooling, typically denoted as equivalent full load hours (EFLH). EFLH accounts for variations in operating hours and was calculated based on the estimated annual energy consumption and coincident thermal demand for a given PSS.

EFLH and the respective heating and cooling capacity of a given GCHP system were used to calculate the annual heating energy ( $E_h$ ) and cooling energy ( $E_c$ ) supplied by that system.<sup>15</sup>

$$\text{Equation 3: } E_h = Q_h \times \text{EFLH}_h$$

$$\text{Equation 4: } E_c = Q_c \times \text{EFLH}_c$$

The maximum capacity and thermal energy supplied by a GCHP system for heating and cooling were then compared to the coincident demand and

thermal energy needs of a given PSS to determine the minimum number of trenches, or the minimum number and depth of boreholes required.

### 3.1 Balancing and Optimization

Each of the PSS modeled for this Study represent varying degrees of difference between annual heating and cooling loads. This difference is most substantial in the low and medium density residential PSS, as they lack the diversity provided by a mix of building uses.

If a GCHP were simply sized to meet both the coincident heating or cooling demand for any one of these PSS, it would overproduce the greater of the two values to compensate for the lesser. The resulting difference between the heat extracted and rejected into the ground would create an imbalanced condition, potentially resulting in reduced system performance and environmental issues.<sup>16</sup>

In order to maintain system performance, the system energy balance (i.e., the difference between annual heating and cooling loads met by a GSHP systems) should remain less than 10 to 15 percent. This Study calculated energy balance as the difference between heating and cooling consumption divided by the sum of those values.

$$\text{Equation 5: Energy Balance} = |E_c - E_h| / (E_c + E_h)$$

14 American Society of Heating, Refrigerating and Air-Conditioning Engineers, "Geothermal Heating and Cooling: Design of Ground-Source Heat Pump Systems (GSHP)." 2014.

15 Ibid.

16 See Chapter II, Section 3.2 of this Study for a description of thermal imbalance.

## Prototype Street Segment Heating and Cooling Loads

Annual Heating and Cooling Consumption

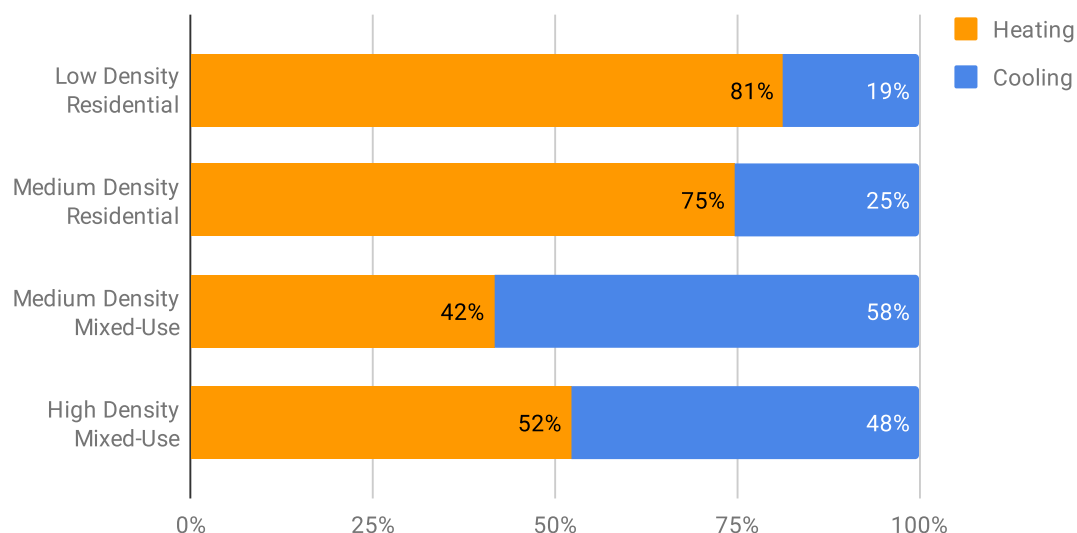

Figure III-5: Comparison of residential and commercial peak heating demand patterns

Energy balance can be maintained by either undersizing the GSHP system to meet the lesser of heating and cooling loads, or by connecting external heat sources or sinks capable of taking off the excess load, thus creating a hybrid system.<sup>17</sup>

External sources or sinks include nearby buildings with larger than average heating or cooling loads, such as data centers, refrigeration plants, hockey and ice-skating rinks, and some museums. Solar thermal systems, industrial chillers, or central boiler plants may also be used to augment the system's heating or cooling capacity, helping to balance the system.

The interconnection of individual GeoMicroDistricts, linked with additional external heat sources, and sinks, would create an efficient, utility-scale thermal network (i.e., a HEET Grid). Although the design, operation, and management of a HEET Grid is complex, it would yield higher GSHP capacities without creating an imbalanced condition and would capture and productively reuse otherwise wasted thermal energy.<sup>18</sup>

Two conditions for GSHP system sizing, based on the heating and cooling loads met by a given system, were established to evaluate the added benefit of a hybrid GSHP system for each PSS:

1. **Balanced (Partial Load):** The street-scale GCHP system is undersized to meet the greater of annual PSS heating or cooling loads. Assumes that an external heat source/sink is not available.
2. **Interconnected (Full/Maximum Load):** The street-scale GCHP system is sized so that both heating and cooling loads are fully met. In cases where the thermal source is not sufficient to meet full loads, the maximum capacity is used. Assumes that an external heat source/sink is available to take off excess heating or cooling.

## 4 GSHP System Performance

The performance of GCHP systems—specifically, the ability of those systems to meet PSS heating and cooling loads—was modeled for each PSS under balanced and interconnected conditions,

<sup>17</sup> American Society of Heating, Refrigerating and Air-Conditioning Engineers, "HVAC Applications." 2015.

<sup>18</sup> It should be noted the design of any interconnected GSHP system would require reevaluated upon each new connection.



utilizing either the area available within a two-foot utility ROW or that within the full 40-foot ROW width. It should be noted that, because of spacing requirements, the full ROW would only accommodate two to three lines of trenches or two lines of boreholes.

Each of the scenarios modeled is based on a bedrock depth of 35 feet below the surface, covered by a layer of dry gravel and/or sandy soil, which is common in Massachusetts and is the most conservative assumption in terms of specific heat extraction (i.e., thermal conductivity). The thermal conductivity of the bedrock was based on metamorphic rock, which is relatively higher than that of sedimentary, but is the same as granite; metamorphic and granite are two of the most common bedrock types found in Massachusetts.

For all but the low density residential PSS evaluated, horizontal GCHP systems were unable to meet 100 percent of either heating or cooling loads with the parameters modeled. Conversely, vertical GCHP systems were able to meet full heating and cooling loads for the low density residential and medium density mixed-use PSS, and approximately 90 percent of heating and 100 percent of cooling loads for the medium density residential PSS.

Interconnecting the medium density mixed-use and residential PSS resulted in even better performance, as the excess cooling capacity in the former and heating capacity in the latter created a balanced condition where both heating and cooling loads could be fully met.

No GCHP system modeled was capable of meeting full heating or cooling loads for the high density mixed-use PSS with the given constraints, however greater capacities for vertical systems may be possible depending on ground conditions and borehole depth.

## 4.1 Low Density Residential

The low density residential PSS was the only one where a horizontal GCHP system could meet a reasonable share of building heating or cooling loads. A horizontal coil system consisting of three lines of trenches (i.e., the full ROW) installed in soil could meet 100 percent of cooling loads and slightly more than 30 percent of heating loads. Installation in saturated soil, which has a higher thermal conductivity, increases the system capacity to meet 90 percent of heating loads. However, this assumes the system is interconnected to balance the load.

A vertical GCHP system consisting of a single line of 32 125-foot deep boreholes along a single utility ROW could meet 100 percent of cooling loads and around 30 percent of heating loads in a balanced condition for the low density residential PSS. The same configuration with a borehole depth of 350 feet could meet full heating and cooling loads if interconnected, although a significant amount of excess cooling loads would need to be taken off or offset by an external building or thermal source to avoid over-cooling the ground. This result could also be achieved with two rows of 32 boreholes at 200 feet deep but would require use of the entire ROW.

## 4.2 Medium Density Residential

A vertical GCHP system consisting of two lines of 30 250-foot deep boreholes along the entire ROW could meet 100 percent of cooling loads and around 40 percent of heating loads in a balanced condition for the medium density residential PSS. The same configuration with a 500-foot borehole depth could meet up to 90 percent of heating loads in an interconnected condition, albeit with significant excess cooling.

The use of additional yards, parks, parking lots, or other open space for additional boreholes could increase capacity to meet full heating and cooling loads. Moreover, interconnection with an adjacent GeoMicroDistrict with excess heating capacity (i.e., a mixed-use or commercial street segment) could both satisfy heating demand and maintain thermal balance within the entire system.

## 4.3 Medium Density Mixed-Use

A vertical GCHP system consisting of two lines of 30 275-foot deep boreholes along the entire ROW could meet nearly 60 percent of cooling loads and 100 percent of heating loads in a balanced condition for the medium density mixed-use PSS. The mix of residential and commercial uses in this PSS results in a higher cooling load, in contrast to the two residential-only PSS. The same configuration with a 475-foot borehole depth could meet 100 percent of both heating and cooling loads if interconnected, although an external building or thermal source would be needed to avoid overheating the ground.

## 4.4 High Density Mixed-Use

Neither horizontal nor vertical GCHP systems were feasible for the high density mixed-use PSS. A vertical GCHP system consisting of two lines of 30 500-foot deep boreholes along the

## Technical Feasibility: GCHP Closed Horizontal

Annual Heating and Cooling Loads Met (Interconnected)

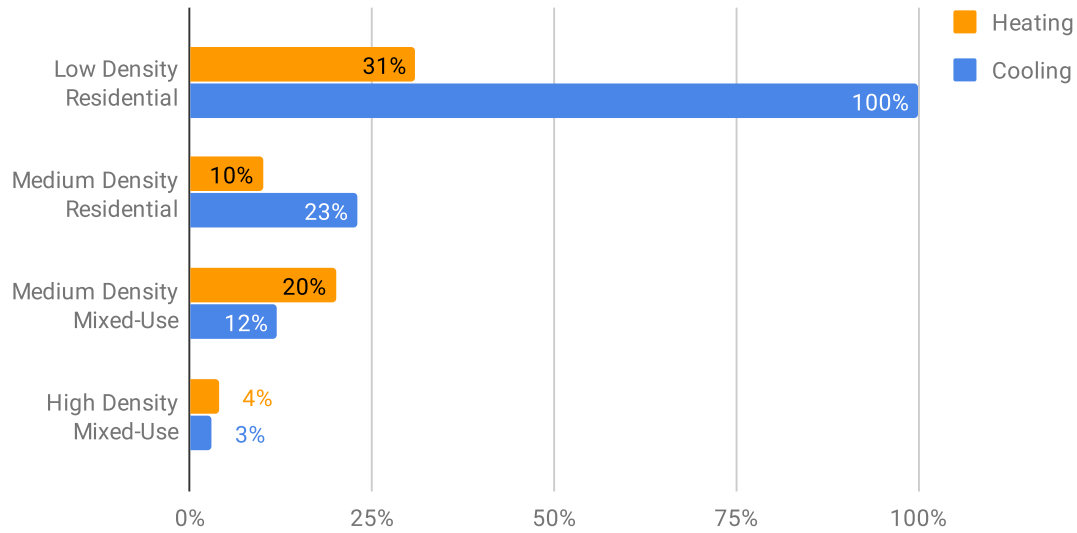

Figure III-6: Comparison of annual thermal loads met by horizontal GCHP systems

## Technical Feasibility: GCHP Closed Vertical

Annual Heating and Cooling Loads Met (Interconnected)

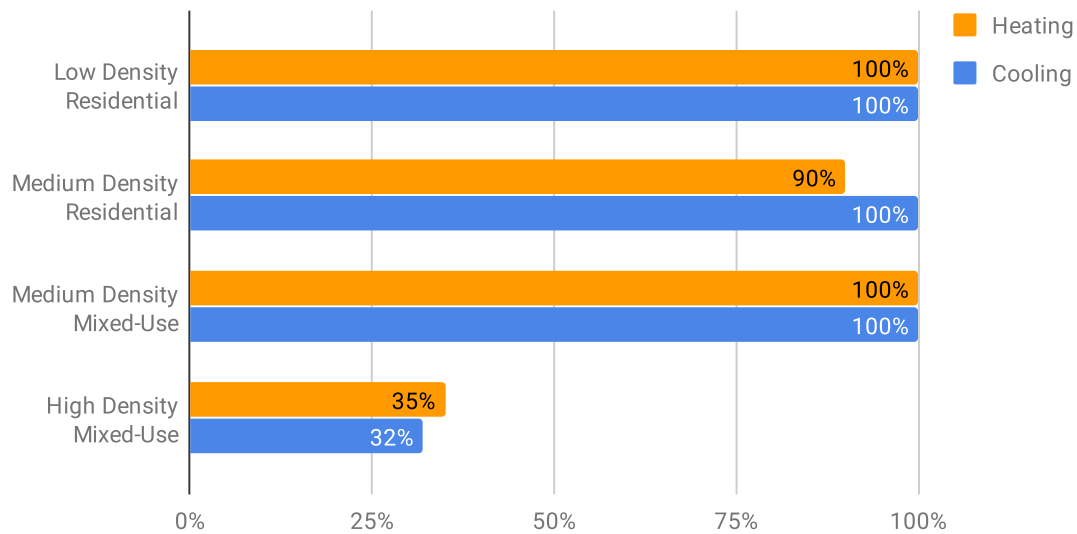

Figure III-7: Comparison of annual thermal loads met by vertical GCHP systems

entire ROW could meet only about 30 percent of cooling loads and 35 percent of heating loads. The heating and cooling demands for the amount of floor area represented by this PSS are simply too great compared to the amount of installation area available within the ROW. However, as previously noted, the use of adjacent parking lots, parks, or other open spaces for GCHP installation may provide additional capacity.

The age and density of underground infrastructure (e.g., water and sewer mains, telecom lines) in highly developed urban areas such as Boston may also pose a challenge for GCHP installation, although

initiatives such as the Boston Smart Utilities Project may provide an opportunity for installing GSHP systems as part of a wider modernization effort.<sup>19</sup>

Deeper boreholes and other newer innovations such as boreholes in pilings may also expand the opportunity in these denser areas. Furthermore, excess heat from surrounding, lower-density mixed use areas may provide an additional source of thermal energy. It is this larger scale design and management of the thermal network that is best suited for utility-scale management and optimization.

---

<sup>19</sup> Boston Planning & Development Agency, Boston Smart Utilities Project. <http://www.bostonplans.org/planning/planning-initiatives/boston-smart-utilities-project>

# Chapter IV: Economic Feasibility

## 1 GSHP Installation Costs

This Study assumes that a utility company would capitalize, install, and manage the GeoMicroDistrict infrastructure, including any supplemental or backup heating and cooling installed on the ground loop, service lines to each customer building, along with meters capable of accurately billing thermal energy pulled from the system. Individual customers would, behind the meter, provide the heat pumps required to exchange heat with the ground loop and the building's heating and cooling distribution systems.

It should be noted that the following estimates do not include the cost of funding new or expanded energy efficiency and clean energy programs established by the State, although such incentives are included with the building conversion costs described in Section 3 of this Chapter. Only incentives provided by currently existing programs were applied.

Similar to the engineering feasibility analysis described in Chapter III of this Study, the economic feasibility analysis for this Study focused on GCHP systems because of their wide applicability and relatively high capacities available for a number of site conditions. For the economic analysis, installation costs were modeled for horizontal loop, horizontal coil, and vertical GCHP systems installed within the ROW of each PSS identified in Chapter III.

Estimated installation costs for each GSHP system included the following items:

- Trenching or borehole drilling costs.
- Drilling rig setup and breakdown, where applicable.
- Loop piping and installation, circulating pumps.
- Service connections to buildings.

Additional allowances were estimated for the following soft costs:

- Public ROW work (e.g., street closure).
- Design and engineering.
- Permits and approvals.
- Contractor overhead, profit, and contingency.

It should be noted that heat pump units were considered building conversion, rather than GSHP system costs.

Unit costs were estimated for each item based on a variety of sources, including the construction cost estimating service RSMMeans, GSHP installation costs reported to the Massachusetts Clean Energy Center (MassCEC), and input from various technical stakeholders involved with this Study. GCHP and backup systems were sized based on the heating and cooling loads of buildings that had already undergone energy efficiency retrofits described in Chapter II of this Study. Allowances were estimated as a percent of materials and labor costs and were purposefully conservative to account for the various contingencies associated with work on a public ROW.

It is important to note that this analysis is only intended to provide a rough order of magnitude estimate of potential costs. A more detailed assessment performed by an experienced professional based on specific site and building conditions is needed to fully understand the costs involved with any individual project.

According to MassCEC data, the average cost of installing a vertical GCHP system in Massachusetts is approximately \$13,000 per ton of heating capacity, about 45 percent higher than the \$9,000 per ton cost for a horizontal GCHP. However, reported installation costs for vertical systems ranged from below \$3,000 per ton to more than \$40,000 per ton, regardless of the size of the system installed. This may be the result of adverse site conditions, the need for extensive retrofits to existing heating and cooling systems, or smaller installations where the cost of setting up the drill rig and other equipment, relative to the actual capacity installed, inflates the per-ton cost.<sup>1</sup>

Although MassCEC data provides an empirical basis for estimation, it may not accurately represent the costs of implementing a GeoMicroDistrict. First, the dataset is based on applications to the MassCEC Residential and Small-Scale GSHP program, which is generally limited to systems providing 10 tons of heating or less. Further, this data may be skewed

<sup>1</sup> Massachusetts Clean Energy Center, Ground-Source Heat Pump Program- Residential & Small-Scale Projects, September 2018.

## Existing GSHP System Installation Costs

Total System Cost versus Total Capacity

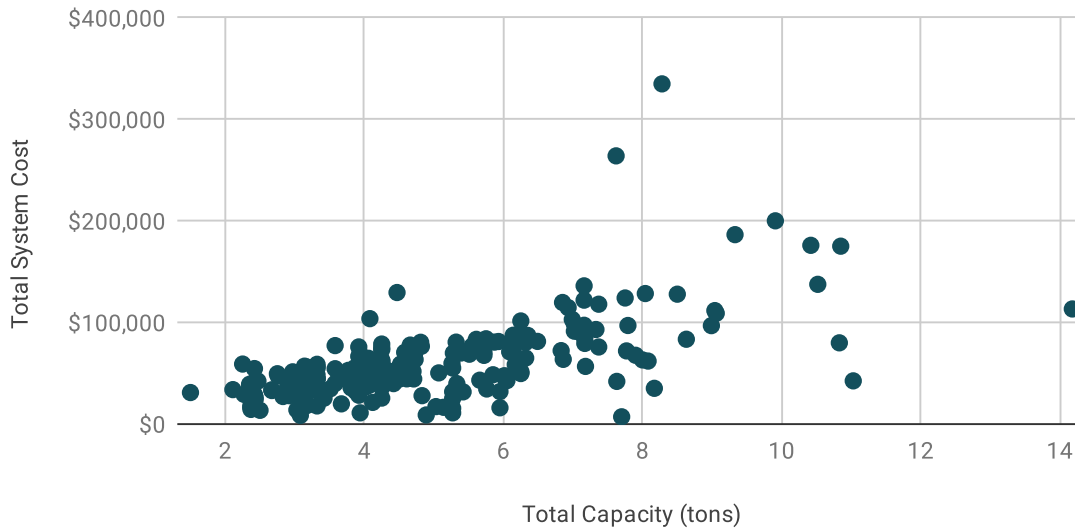

Figure IV-1: Existing GSHP installation costs in Massachusetts

Table IV-1: Characteristics for existing vertical and horizontal GSHP systems installed in Massachusetts

System Characteristics	Horizontal GCHP	Vertical GCHP	All Installations
Count of Installations	16	203	258
Avg. Building Size (square feet)	3,453	3,596	3,597
Building Size Range	1,675 - 8,912	790 - 18,128	790 - 18,128
Heating Capacity (tons)	4.4	4.8	4.8
Heating Capacity Range	2.4 - 8.2	1.5 - 14.2	1.5 - 14.2
System Cost per Capacity (\$/ton)	\$9,057	\$13,343	\$12,394
System Cost per Capacity Range	\$924 - \$17,326	\$2,791 - \$40,443	\$924 - \$40,443

Table IV-2: Case study installation costs for district GSHP systems

Case Study	Project Type	System Type	System Capacity (tons)	System Cost (\$ per ton)
Stockton University (NJ)	Retrofit	Vertical GCHP	1,741	\$2,929
West Union District System (IA)	Retrofit	Vertical GCHP	264	\$8,712
Ball State University (IN)	Retrofit	Vertical GCHP	12,600	\$6,579
South Caribou Recreation Centre (BC)	Retrofit and New	Horizontal GCHP	23	\$4,375

towards more expensive projects and over-reporting may have occurred in an attempt to drive up rebate amounts.

A limited number of case studies were performed for this Study to evaluate whether district GSHP systems installed in North America were less expensive, per ton, than smaller-scale systems.<sup>2</sup> The results show no clear cost premium associated with district GSHP systems. Moreover, the per-ton costs cited for University installations were slightly less than those for the West Union District System in West Union, Iowa, which has a similar configuration to a GeoMicroDistrict.

It should be noted that the West Union project included the conversion of 60 existing buildings served by the system, the cost of which was nearly four times as much as the system itself. However, the cost of installing the GCHP system was fully funded by federal grants and building conversions were supported by low-interest financing, utility rebates, and federal funding.

## 1.1 Horizontal GCHP Systems

Horizontal GCHP systems are only suitable in lower-density areas where sufficient space is available for trenching and heating cooling loads are lower. They are generally not suitable for installation in an existing ROW, although there are opportunities for ROW installations in new developments.

Although horizontal GCHP systems were modeled for all four PSS, they were only capable of meeting a meaningful portion of heating and cooling loads for the low density residential PSS. A six-ton horizontal coil GCHP system installed along three lines of trenches within the ROW would meet 100 percent of cooling loads, but only 31 percent of heating loads. Remaining heating loads would need to be met with natural gas boilers in a central location (e.g., a utility shed) with natural gas service.

This scenario would result in an estimated installation cost of approximately \$27,000 to \$47,000 (about \$4,000 to \$5,000 per heating ton), which is slightly lower than the MassCEC average for horizontal GCHP systems.

## 1.2 Vertical GCHP Systems

Vertical GCHP systems were found to be suitable across all land use types, although their performance was limited in higher-density areas because of the combination of high heating and cooling loads and site constraints (i.e., limited area, density of underground utility lines).

In the low density residential scenario, a single line of boreholes along the utility ROW was sufficient to meet heating and cooling loads, whereas two lines of boreholes were needed for the medium density mixed use scenario. However, both cases require the PSS to export excess thermal energy to provide thermal balancing and avoid long-term issues (e.g., overheating or freezing the ground). A balanced condition would require electric chillers in a central location to meet remaining cooling loads.

### 1.2.1 Low Density Residential

For the low density residential PSS, a six-ton vertical GCHP system capable of meeting 100 percent of cooling loads and 31 percent of heating loads, with additional backup heating, would result in an estimated installation cost of approximately \$174,000 to \$268,000 (about \$28,000 to \$37,000 per heating ton), which is higher than the MassCEC average for vertical GCHP systems. A majority of installation costs were attributed to borehole drilling, which includes the drill rig setup and breakdown in addition to labor and materials.

### 1.2.2 Medium Density Mixed Use

For the medium density mixed-use PSS, a 58-ton vertical GCHP system capable of meeting 59 percent of cooling loads and 100 percent of heating loads, with additional backup cooling, has an estimated installation cost of approximately \$375,000 to \$585,000 (\$7,000 to \$14,000 per heating ton), which is slightly lower than the MassCEC average for vertical GCHP systems. It should be noted that at this capacity, the GCHP system could be limited to the utility ROW if a greater borehole depth were used (i.e., greater than 500 feet).

A majority of installation costs were attributed to borehole drilling and labor and materials associated with the ground loop. A relatively large portion of installation costs were associated with the pumps used to move the circulating fluid through the thermal network.

<sup>2</sup> See Appendix B of this Study for full case studies.

## GCHP Closed Vertical: Average Installation Costs

Low Density Residential

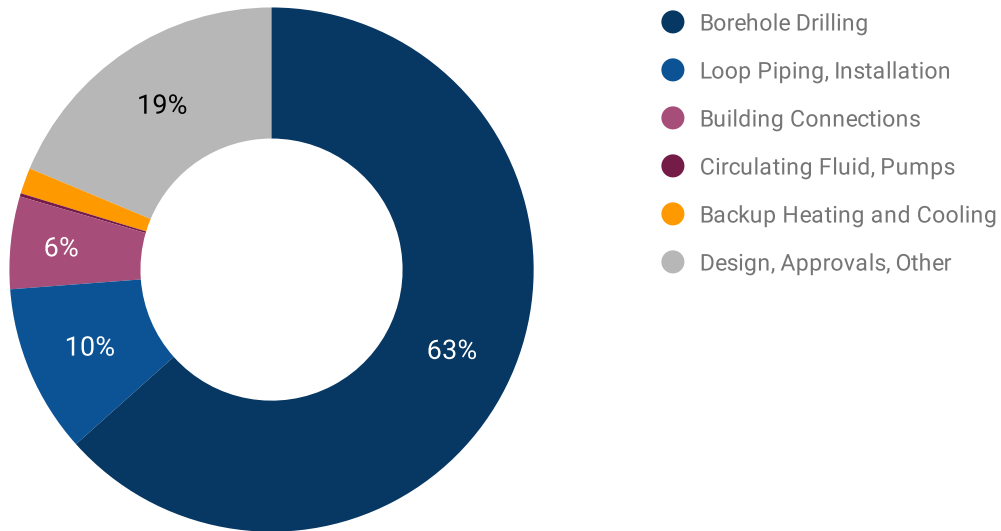

Figure IV-2: Installation costs for a vertical GCHP system serving the low density residential PSS

## GCHP Closed Vertical: Average Installation Costs

Medium Density Mixed-Use

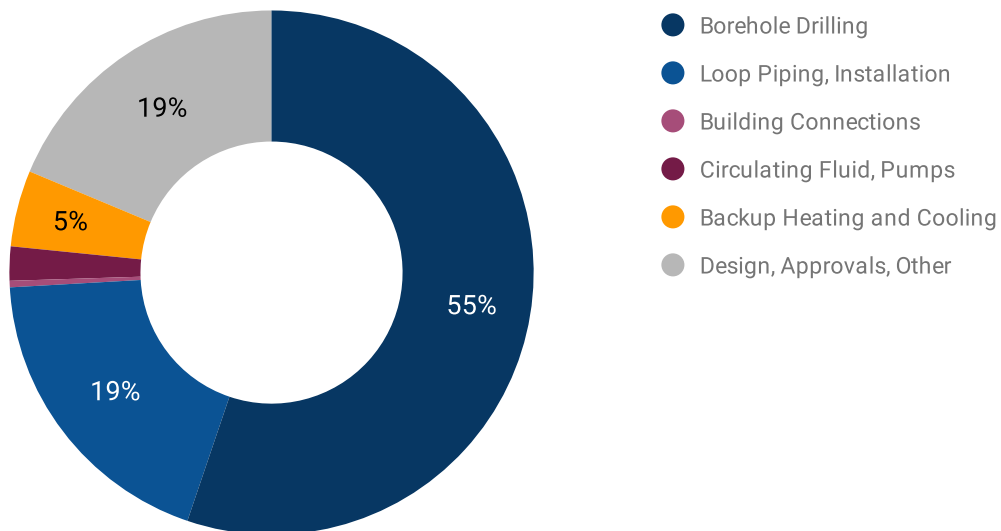

Figure IV-3: Installation costs for a vertical GCHP system serving the medium density mixed-use PSS

Table IV-3: Estimated operating costs for selected PSS and GCHP systems

Prototypical Street Segment	GCHP System	Total Cost (\$/year)	Circulation Pumps (\$/year)	Backup Heating (\$/year)	Backup Cooling (\$/year)
Low density residential	Horizontal coil	\$2,200	\$400	\$1,800	-
Low density residential	Vertical	\$2,200	\$400	\$1,800	-
Medium density mixed-use	Vertical	\$7,500	\$2,200	-	\$5,300

## 2 GSHP Operating Costs

This Study focused on the energy costs associated with operating a street-scale GCHP system. This includes the cost of operating individual heat pumps within PSS buildings, the cost of operating the pumps used to circulate heat transfer fluid through the piping network, and the cost of operating backup heating and/or cooling equipment. This Study did not consider the ongoing maintenance costs associated with a GSHP system (e.g., repair and replacement of piping and other components), although such costs are typically lower than those for traditional heating and cooling systems.

This Study assumes that the utility company would bear the costs of operating circulating pumps and backup heating and cooling. Individual building owners were assumed to bear the costs of operating individual heat pump units. The costs of utility-provided GSHP heating and cooling were not addressed. Although an initial rate analysis was performed as part of this Study, it was later abandoned due to the complexity of the ratemaking process, the number of possible approaches to allocating costs, and the multiplicity of other factors that would need to be considered (e.g., insurance, depreciation, incentive programs).

### 2.1 GSHP Utility Costs

The energy required to operate circulation pumps was estimated at 15 percent of the total energy required for individual heat pump units. Electricity prices were based on U.S. Energy Information Administration (EIA) projections for industrial customers in New England.<sup>3</sup>

For the low density residential PSS, the energy required to operate circulation pumps would cost approximately \$400 per year for either a horizontal or vertical GCHP system. For the medium density mixed-use PSS with a vertical GCHP system, pump operation would cost approximately \$2,200 per year. However, pump operation represents a relatively small share of operating costs compared to those for backup heating and cooling, which is likely to be required in the first GeoMicroDistricts.

It should be noted that backup heating and cooling costs could be mitigated by design. For example, oversizing the GCHP system and selling the excess heating and cooling capacity to nearby customers, or interconnecting a GeoMicroDistrict with other GeoMicroDistricts or adjacent buildings to add load diversity and make use of existing sources and sinks.

However, in an initial install of a stand-alone GeoMicroDistrict without any mitigation, operating a natural gas boiler to provide backup heating for the low density residential scenario would cost approximately \$1,800 per year for either GCHP system. For the medium density mixed-use PSS, backup cooling would cost approximately \$5,300 per year for a vertical GCHP system; backup heating would not be required.

### 2.2 GSHP Customer Costs

The energy required to operate customer (i.e., behind the meter) heat pump units was determined based on the estimated heating and cooling loads for each building, and the estimated heating and cooling efficiencies (i.e., coefficients of performance) for each of the GSHP systems evaluated.<sup>4</sup> Electricity

<sup>3</sup> U.S. Energy Information Administration, Annual Energy Outlook 2019, Table 3: Energy Prices by Sector and Source. <https://www.eia.gov/outlooks/aeo/>

<sup>4</sup> See Chapter II, Section 3 and Chapter III, Section 3 of this Study for estimated building energy loads and GSHP efficiencies, respectively.



## GCHP Closed Vertical: Average Annual Operating Costs

Low Density Residential

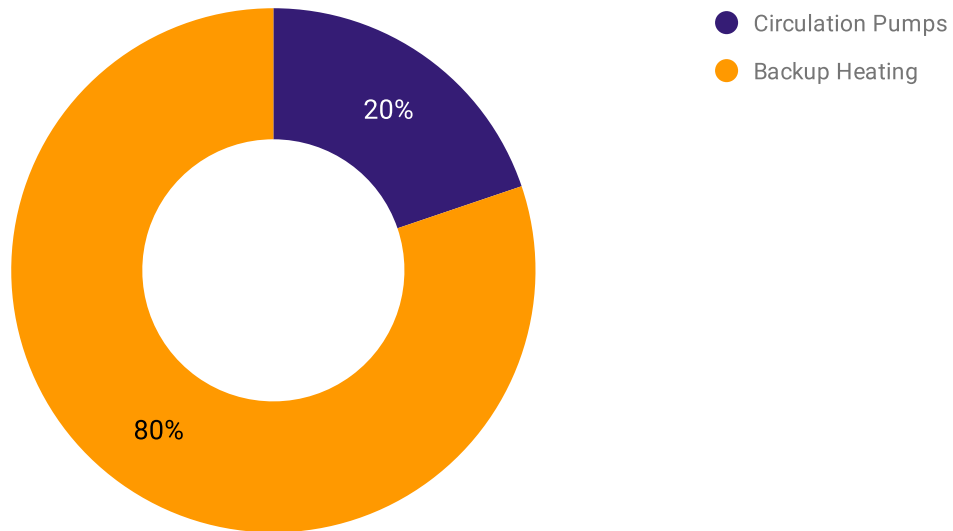

Figure IV-4: Operating costs for a vertical GCHP system serving the low density residential PSS

## GCHP Closed Vertical: Average Annual Operating Costs

Medium Density Mixed-Use

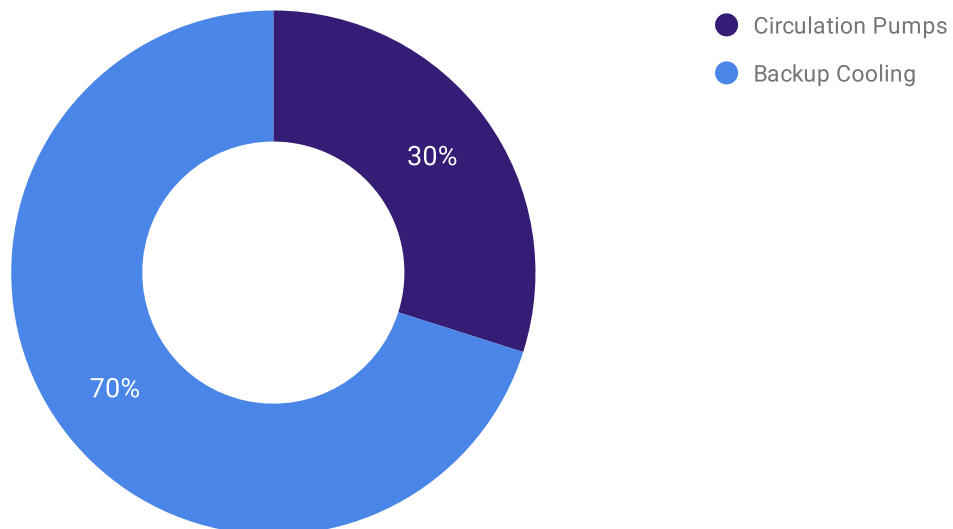

Figure IV-5: Operating costs for a vertical GCHP system serving the medium density mixed-use PSS

Table IV-3: Estimated heat pump operating costs for selected PSS and GCHP systems

Prototypical Street Segment	GCHP System	Residential Cost per Unit (\$/year)	Commercial cost per Unit (\$/year)
Low density residential	Horizontal coil	\$600	-
Low density residential	Vertical	\$600	-
Medium density mixed-use	Vertical	\$400	\$1,700

prices for heat pump operation were based on EIA projections for residential and commercial customers in New England.

The electricity required to operate heat pumps in residential properties in the low density residential PSS would cost approximately \$600 per year for each household.<sup>5</sup> Electricity for heat pump operation in the medium density mixed-use PSS would cost approximately \$400 per year for residential units, and \$1,700 for commercial units.<sup>6</sup>

As mentioned previously in this Section, the price of utility-provided GSHP heating and cooling was ultimately not included in this Study due to challenges associated with estimating rates for future GSHP customers. Therefore, the relative savings or additional cost for heating and cooling within a GeoMicroDistrict could not be accurately determined.

### 3 Building Conversion Costs

Existing buildings within a GeoMicroDistrict would require alterations to replace heating and cooling equipment with a heat pump and, in some cases, a new interior distribution system. Existing domestic hot water (DHW) heaters and any appliances that use natural gas (i.e., stoves, ovens, and clothes dryers) would need to be replaced with electric models, as gas service would no longer be provided to individual buildings.

Conversion costs were based on estimates from the U.S. EPA, MassCEC data, previous research and reports, and retail prices for home appliances. The actual cost of building conversions will vary to a great degree based on the age, existing systems, and ownership (e.g., owner-occupied,

condo associations, rentals), among other factors. Although some of these home appliances would likely need to be replaced, this was not factored into the calculations to provide a more conservative estimate.

The GCHP systems evaluated for this and the technical analysis were sized to meet heating and cooling loads for existing buildings that had undergone an energy efficiency retrofit, and the costs of such retrofits were included in conversion cost estimates. Certain incentives for energy efficiency, GSHP systems, and DHW heat pumps were also included in conversion cost estimates.

Although it is possible that the incentive programs referenced will change before the first street-scale GSHP is implemented, they provide a rough measure of what may exist in the future. As noted in Section 1 of this Chapter, these programs are funded by utility companies, and their expansion, as with all utility work, ultimately adds to ratepayer cost.

#### 3.1 Residential Buildings

As expected, a significant portion of residential conversion costs is associated with the installation of heat pump equipment and interior distribution equipment. Although a relatively large portion of conversion costs was associated with new appliances, it should be noted that these costs vary depending on whether existing appliances are electric or gas and, in the case of multifamily properties, the ratio of gas dryers to residential units.<sup>7</sup>

This analysis included incentive amounts based on the MassCEC Small-Scale GSHP program, which provides a \$2,000 per ton rebate for systems with a heating capacity of up to 10 tons, and the Mass Save

<sup>5</sup> Assumes 10 residential units at 1,500 square feet each.

<sup>6</sup> Assumes 48 residential units at 1,000 square feet each, and 6 commercial units at 4,500 square feet each.

<sup>7</sup> Assumes three dryers for every four residential units.

## Single-Family Residential Conversion Costs

Low Density Residential

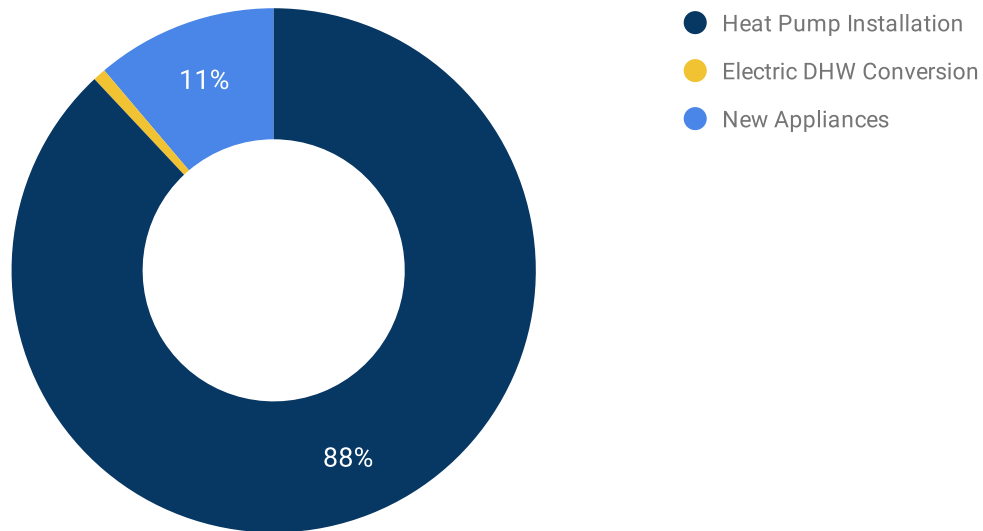

Figure IV-6: Conversion costs for single-family residential buildings

## 2-3 Family Residential Conversion Costs

Medium Density Mixed-Use

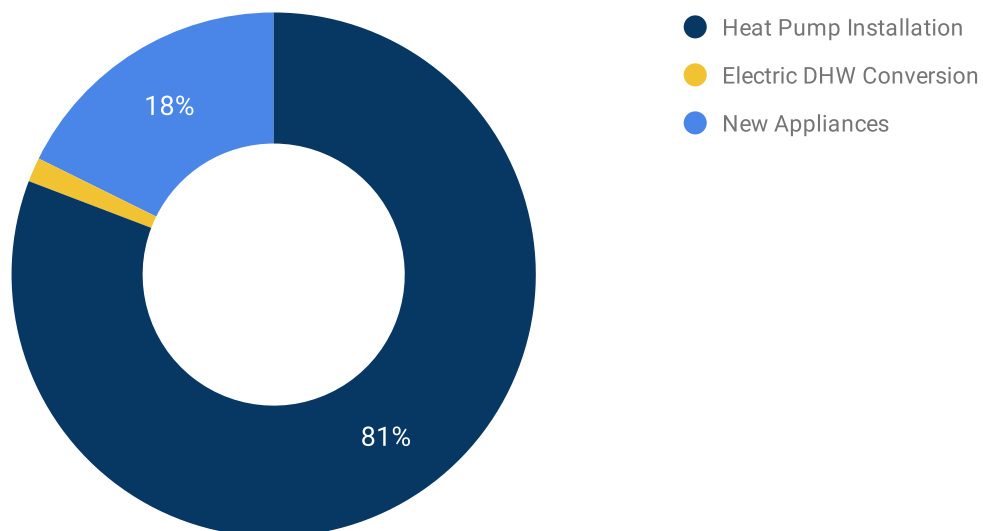

Figure IV-7: Conversion costs for 2-3 family residential buildings

Electric Water Heat Pump Rebate, which provides up to \$600 for residential customers.<sup>8</sup> It should be noted that the Mass Save HEAT Loan program would provide up to \$25,000 for energy efficiency improvements at zero percent interest, which would help defray the initial costs of GCHP conversion.<sup>9</sup>

### 3.2 Commercial Buildings

A majority of commercial conversion costs were associated with GCHP conversion, as stoves, ovens, and clothes dryers are generally not found in commercial spaces. Although DHW demand may be higher for commercial properties, the cost of a new DHW system compared to that for GCHP conversion is minimal.

### 3.2 Commercial Buildings

A majority of commercial conversion costs were associated with GCHP conversion. The costs associated with the replacement of home appliances such as stoves, ovens, and clothes dryers were excluded, as such appliances are less likely to be found in commercial spaces. Although DHW demand may be higher for commercial properties, the cost of a new DHW system compared to that for GCHP conversion is minimal.

This analysis included incentive amounts based on the MassCEC commercial-scale GSHP program, which provides a \$2,000 per ton rebate, with a \$250,000 maximum, for systems with a heating capacity greater than 10 tons. It should be noted that the Mass Save Financing for Business Program offers low-interest loans up to \$500,000 for energy efficiency retrofits for commercial customers.<sup>10</sup>

---

8 Massachusetts Clean Energy Center, Residential Clean Heating and Cooling. <https://www.masscec.com/residential/clean-heating-and-cooling>

Mass Save, High-Efficiency Electric Water Heater Rebates. <https://www.masssave.com/en/saving/residential-rebates/electric-heat-pump-water-heaters/>

9 Mass Save, HEAT Loan Program. <https://www.masssave.com/en/saving/residential-rebates/heat-loan-program/>

10 Mass Save, Financing for Business Program. <https://www.masssave.com/en/learn/business/the-mass-save-financing-for-business-program/>

Table IV-4: Estimated residential conversion costs for the low density residential PSS

Residential GCHP Conversion Costs	Total Conversion Cost	Conversion Cost per Unit (\$/unit)
Energy efficiency retrofit	\$26,000 - \$53,000	\$2,600 - \$5,300
GCHP conversion	\$40,000 - \$120,000	\$4,000 - \$12,000
New Appliances	\$8,000 - \$13,000	\$800 - \$1,300
Available incentives	(\$57,000 - \$68,000)	(\$5,700 - \$6,800)
<b>Total</b>	<b>\$17,000 - \$118,000</b>	<b>\$1,700 - \$11,800</b>

Table IV-5: Estimated residential conversion costs for the medium density mixed-use PSS

Residential GCHP Conversion Costs	Total Conversion Cost	Conversion Cost per Unit (\$/unit)
Energy efficiency retrofit	\$60,000 - \$120,000	\$1,250 - \$2,500
GCHP conversion	\$113,000 - \$335,000	\$2,354 - \$6,979
New Appliances	\$37,000 - \$60,000	\$771 - \$1,250
Available incentives	(\$175,000 - \$211,000)	(\$3,646 - \$4,396)
<b>Total</b>	<b>\$35,000 - \$304,000</b>	<b>\$729 - \$6,333</b>

Table IV-4: Estimated commercial conversion costs for the Medium Density Mixed-Use PSS

Commercial GCHP Conversion Costs	Total Conversion Cost	Conversion Cost per Unit (\$/unit)
Energy efficiency retrofit	\$61,000 - \$95,000	\$10,167 - \$15,833
GCHP conversion	\$183,000 - \$548,000	\$30,500 - \$91,333
Available incentives	(\$182,000)	(\$30,333)
<b>Total</b>	<b>\$62,000 - 461,000</b>	<b>\$10,333 - \$76,833</b>

# Chapter V: Conclusion

## 1 Findings

District-scale GSHP systems, specifically vertical GCHP, installed within the public ROW are technically capable of meeting the heating and cooling needs of buildings in low to medium density residential and mixed-use commercial districts in Massachusetts. Moreover, such systems can provide a viable alternative to natural gas heating and help mitigate the environmental, health, and safety issues associated with the distribution and combustion of natural gas.

However, the performance and feasibility of GSHP systems may vary greatly depending on individual site conditions (e.g., thermal properties of the ground, building loads, existing underground infrastructure), and a detailed assessment of these conditions conducted by design and installation professionals is absolutely necessary for implementation.

### 1.1 Technical Considerations

The preliminary analysis of site conditions conducted for this Study found that of the three GSHP types identified, GCHP systems were the most broadly applicable and provided the best performance across a range of site conditions. Although GWHP and SWHP systems should be considered as part of any design process, they may face significant regulatory and environmental barriers depending on the jurisdiction and thermal source (e.g., aquifer, pond or lake, river). Because of this, more detailed analysis was limited to GCHP systems.

The findings of this Study show that long-term thermal degradation resulting from unbalanced heating and cooling loads, rather than installation area, is the primary limitation for the performance of street-scale GCHP systems installed within the public ROW (i.e., GeoMicroDistricts).<sup>1</sup> Given that GeoMicroDistricts are intended to interconnect and scale, this is a significant consideration, as large volumes of ground would be affected. This could result in the system becoming damaged and less effective over time if not properly managed.

However, the interconnection of GeoMicroDistricts provides the opportunity to add diverse heating and cooling loads that, in aggregate, would balance

heating- and cooling-dominant building uses (i.e., residential and commercial, respectively) and improve overall efficiency. Moreover, these benefits would increase with the size and diversity of the interconnected system, and larger systems could provide increasing opportunity for low cost, long term thermal energy storage.

Site constraints may limit the feasibility of GCHP systems for certain areas and conditions. Horizontal GCHP systems were unable to meet the full heating or cooling loads for any of the PSS modeled. This is because of the relatively low capacity per installed area for horizontal configurations. Although vertical GCHP systems were able to meet at least 100 percent of either heating or cooling loads for the low and medium density PSS, they could not, independently, meet more than 35 percent of loads for the high density mixed-use PSS.

Finally, it is critical that existing buildings are made as efficient as possible prior to or during GSHP conversion. This allows for the installation of smaller and less expensive systems, reduces customer energy bills, and can increase the performance of the GSHP system.

### 1.2 Economic Considerations

Although this Study attempted to provide a rough order of magnitude estimate of the potential installation and operating costs for a street-scale GSHP system, empirical data is needed to better understand both the economies of scale and hidden costs associated with interconnected systems.

There are few, if any existing instances of GSHP systems within a public ROW that serve existing buildings, and information regarding their associated costs is scarce. Moreover, the reported GSHP installation costs that were used to benchmark the estimates for this Study do not necessarily account for other factors, such as street closure and restoration, associated with GeoMicroDistrict implementation.

The cost of converting an existing building to work with a street-scale GSHP system depends greatly on that building's existing heating and cooling distribution systems, among other factors. Likewise, the degree to which GSHP system customers save

<sup>1</sup> See Chapter II, Section 3.2 of this Study for more information on thermal degradation.

# Technical Feasibility: GCHP Closed Vertical

Annual Heating and Cooling Loads Met (Interconnected)

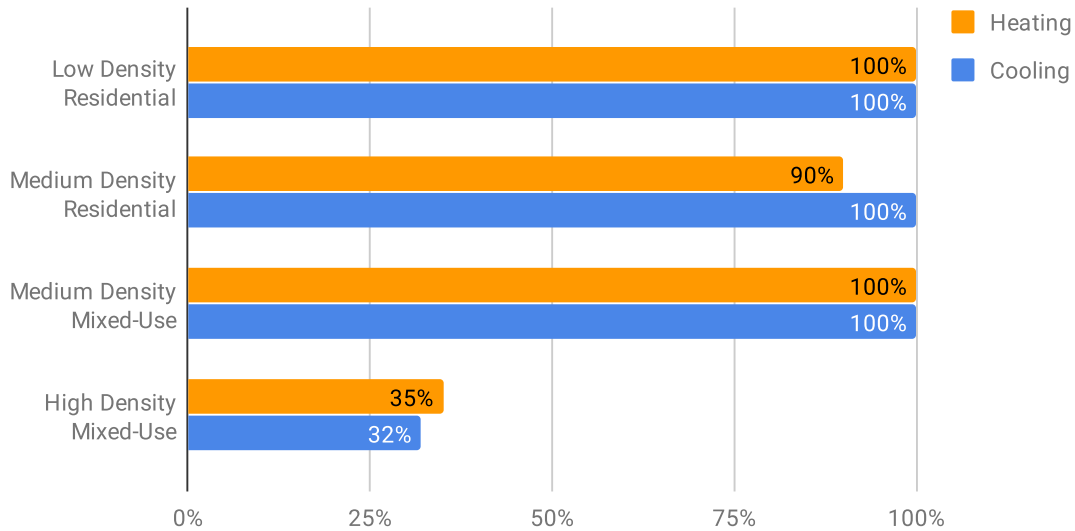

Figure V-1: Comparison of thermal loads met by vertical GCHP systems for each of the PSS modeled

money on utility costs ultimately depends on the efficiency and type of existing heating and cooling systems and the rate structures established by utility companies and the Massachusetts Department of Public Utilities. Regardless, a larger customer base would help decrease installation costs by enabling greater economies of scale and creating a trained workforce, which would in turn decrease heating and cooling rates for customers.

## 2 Key Considerations

GeoMicroDistricts present a viable alternative to natural gas heating, along with a host of additional benefits including greater public safety, climate change mitigation, infrastructure resilience, air quality improvements, and the potential for rapid deployment.

### 2.1 Safety and Resilience

The safety of the gas delivery infrastructure is a major, if not the largest concern for existing gas distribution companies, and GeoMicroDistricts represent a viable “safety first” move for the industry. A GeoMicroDistrict creates much less of a risk to public health than a network of gas pipes,

an issue that is critical to Massachusetts given the September 2018 gas disaster in Merrimack Valley and ongoing smaller incidents. Rather than potentially explosive fuel, a GeoMicroDistrict would circulate water at around the temperature of tap water, and at a pressure close to that of a garden hose.

Although GeoMicroDistricts require electricity to operate, and are thus vulnerable to disruptions to the electricity grid, they consume significantly less electricity than traditional heating and cooling systems, affording the use of renewable energy and storage to provide additional resiliency. Moreover, widespread implementation would reduce peak electricity demand, especially during summer months, potentially limiting the number of forced outages.

### 2.2 Greenhouse Gas Reduction

The replacement of gas boilers and furnaces with a GSHP system would result in a significant reduction in greenhouse gas (GHG) emissions. A low density residential neighborhood could reduce GHG emissions from heating, cooling, and DHW by more than 60 percent if converted into a GeoMicroDistrict. A medium density mixed-use neighborhood could achieve similar reductions.

## Annual GHG Emissions: GCHP Closed Vertical

Low Density Residential

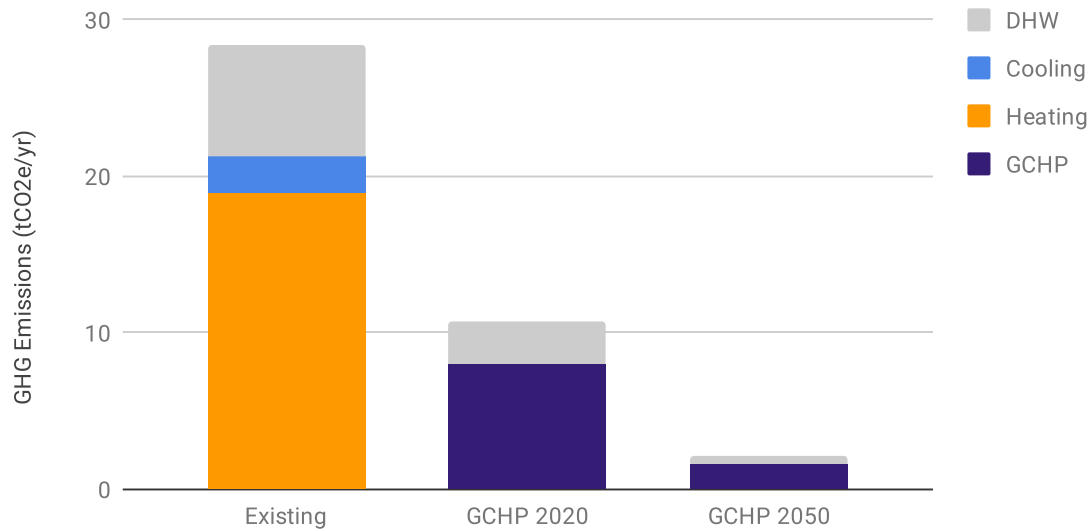

Figure V-2: Low Density Residential GHG emissions from heating, cooling, and DHW

## Annual GHG Emissions: GCHP Closed Vertical

Medium Density Mixed-Use

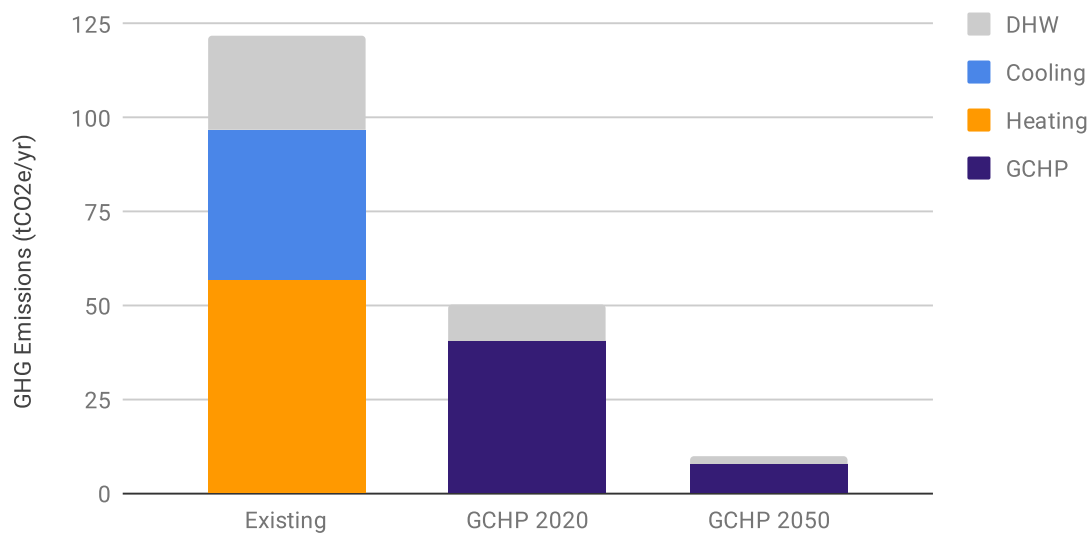

Figure V-3: Medium Density Mixed-Use GHG emissions from heating, cooling, and DHW



Moreover, GHG emissions from electricity used to operate a GSHP system (i.e., the circulation pumps and heat pumps) would decrease over time as more renewable energy capacity is added to the electricity grid. For both of the aforementioned street segments, a more than 90 percent reduction is possible by 2050 if Massachusetts and other states implement their utility-scale renewable energy targets.<sup>2</sup>

## 2.3 Other System Impacts

GeoMicroDistrict implementation repurposes the existing public utility structure, financing, workforce, and customer base to deliver safe, clean, and affordable heating and cooling. The materials, installation methods, and permits currently used to install and repair gas pipes are similar to those used for a GSHP system, meaning that the existing gas utility workforce can transition with minimal retraining. This enables a larger, more rapid, and equitable transition to clean energy than the current building-by-building approach.

An interconnected, renewable thermal energy network also creates benefits for the electricity grid. The use of a GSHP system for cooling would reduce demand during summer peaks, limiting strain on the grid and the potential for outages. Moreover, as buildings move towards electrified sources of

heating and cooling, the lower energy needs of GSHP systems will help utility customers avoid the cost of adding new capacity.

The GeoMicroDistrict represents one side of an energy system composed of two synergistic grids—heat and power, or pipes and wires—that together will facilitate a more rapid and equitable transition to clean energy.

## 3 Next Steps toward Change

HEET is actively working with the State and local governments, utility companies, and customers to identify potential locations for one or more GeoMicroDistrict pilot projects in Massachusetts. These pilot projects will provide essential information on the performance and cost of installing and operating a GeoMicrodistrict. HEET and a group of project partners will identify sites in late 2019, with the intention of breaking ground in 2020.

Following successful pilot(s), HEET will drive forward the transition from natural gas to clean energy by creating a renewable thermal grid from the bottom up, at the speed and scale that this moment in history demands. This Study concludes that the GeoMicroDistrict provides a viable means to achieve this goal, and the implementation of a pilot project is the most important next step in facilitating the transition.

---

<sup>2</sup> Assumes an 80% reduction in 2016 Massachusetts-based grid electricity emissions factors. Massachusetts Department of Environmental Protection, Massachusetts Greenhouse Gas (GHG) Reporting Program Data, Calculation of 2016 GHG Emissions Factors. <https://www.mass.gov/lists/massachusetts-greenhouse-gas-ghg-reporting-program-data>

# Appendix A: Technology Background

## 1 Introduction to Heat Pumps

Heat pumps that are used for space conditioning can be generally categorized as either “air-source” or “ground-source,” depending on the medium into which heat is extracted and/or rejected (i.e., the thermal source). In some cases, heat pumps are further defined by the heating and cooling distribution system, such as “air-to-air” (e.g., an air-source heat pump connected to a forced air system), “water-to-air” (e.g., a ground-source heat pump connected to a forced air system), “air-to-water” (e.g., an air-source heat pump connected to a hydronic system), and “water-to-water” (i.e., a ground-source heat pump connected to a hydronic system). It should be noted that ground-source heat pumps generally use water or a similar fluid medium to transfer heat from the ground or other thermal source to the building distribution system.

To provide cooling in the summer, heat pumps extract heat from indoor spaces and reject that heat outside of the building. In the winter this process is reversed, and heat pumps extract heat from outside the building and release that heat indoors. The movement of heat is facilitated by the refrigeration cycle, which relies on the properties of liquids to absorb heat when changed to a gas, and gases to release heat when changed to a liquid. Heat pumps typically circulate a refrigerant (i.e., the liquid used for heat transfer) through four main components: a condenser, an expansion valve, an evaporator, and a compressor. Heat is extracted and rejected through the evaporator and condenser, respectively, which facilitate the change from liquid to gas and vice-versa. The compressor and expansion valve serve to change the temperature and pressure of the circulating gas or liquid, facilitating the movement of heat.

## 2 Ground-Coupled Heat Pumps

A ground-coupled heat pump (GCHP) exchanges thermal energy with the ground using a series of vertical boreholes or horizontal trenches. A GCHP system consists of one or more heat pumps connected to a network of piping, typically

high density polyethylene (HDPE), embedded horizontally within a series of trenches, or vertically within a series of boreholes. A heat transfer fluid, typically water or water with a non-toxic antifreeze solution such as propylene glycol or ethanol, is circulated through the piping to facilitate the transfer of thermal energy. In both horizontal and vertical configurations, the capacity to transfer heat between the circulating fluid and the ground depends on the thermal properties of the ground itself, the total length of piping, the temperature difference between the fluid and the ground, and the fluid flow rate.

GCHP systems are considered “closed loop” because the circulating heat transfer fluid remains completely sealed within the piping network. This helps prevent the circulating fluid from freezing, and minimizes the risk of potential environmental damage. However, for safety reasons, Massachusetts guidelines establish a setback distance of at least 10 feet from surface water bodies, 25 feet from potential sources of contamination (e.g., septic and oil storage tanks, livestock pens) and 50 feet from private potable water supply wells.<sup>1</sup> Although the relative simplicity and self-contained nature of GCHP systems makes them generally easier to maintain than other GSHP systems, they also tend to have higher capital costs because of the trenching or drilling required for installation.

### 2.1 Horizontal Configurations

For GCHP systems in a horizontal configuration, piping loops are buried horizontal to the ground surface at a relatively shallow depth, typically six to 12 feet or below the local frost line depth.<sup>2</sup> In a horizontal linear configuration, one or two pipes span the length of each trench, which are typically spaced between one to two feet apart. Horizontal coil configurations consist of overlapping circles of pipe, similar in shape to a spring, placed in either a standing or reclined position within the trench. Because of the higher density of piping, trenches for coil configurations must be spaced between five and 15 feet apart, depending on loop length and site conditions, to avoid thermal interference.

<sup>1</sup> Massachusetts Department of Environmental Protection, “Guidelines for Ground Source Heat Pump Wells,” December 2013.

<sup>2</sup> 780 CMR R301.2 establishes a frost line depth of 48 inches for Massachusetts.

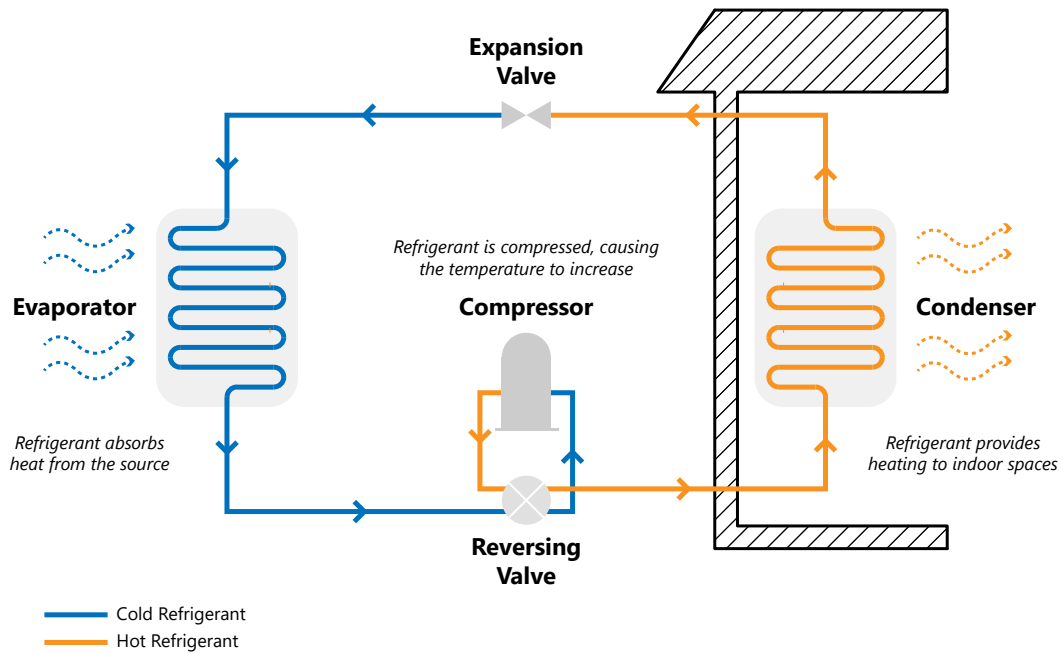

Figure A-1: Heat pump operation for space heating

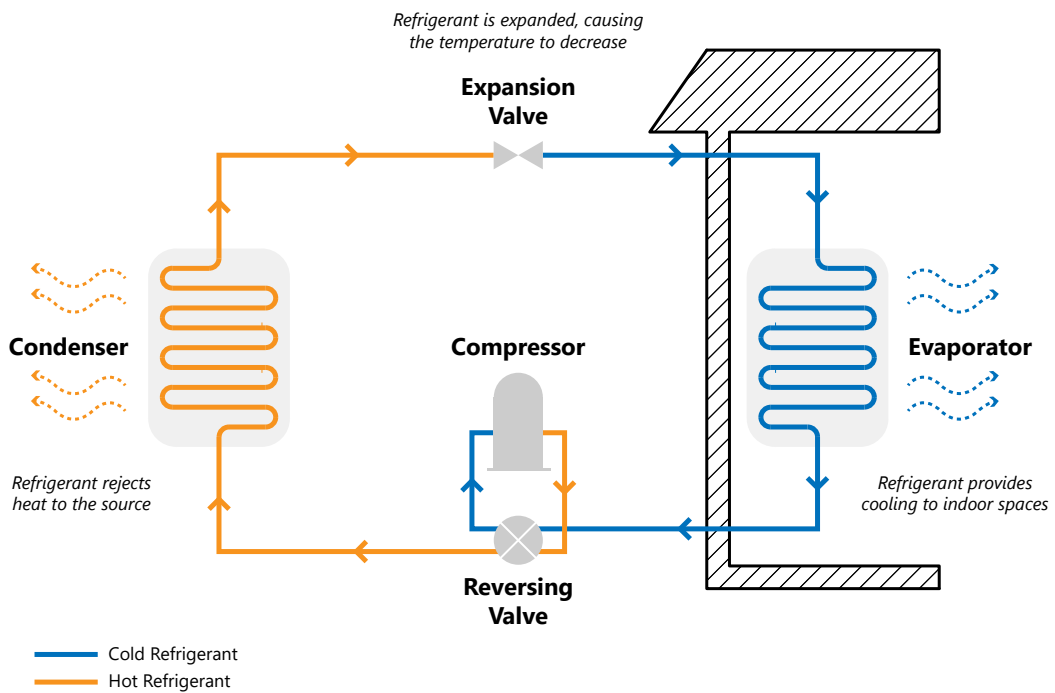

Figure A-2: Heat pump operation for space cooling

The performance of a horizontal GCHP system depends on the size and spacing of trenches and the thermal conductivity of the ground, specifically the moisture content of soils; this is because trenches are often too shallow to reach bedrock. The shallow depth of the loop also makes the system more susceptible to fluctuations in ground temperature and other variables (e.g., heavy rainfall, erosion) that may affect performance.

Horizontal GCHP systems also require the greatest installation area per ton of capacity relative to other GSHP technologies. Although the use of a coil arrangement can reduce the number or length of trenches required, the larger spacing between trenches can mitigate this benefit. Because of this, horizontal GCHP systems may not be ideal for areas where the installation area is limited. However, where there is sufficient area for installation, a horizontal configuration may be less expensive than a vertical GCHP system of a similar capacity.<sup>3</sup>

## 2.2 Vertical Configurations

For GCHP systems in a horizontal configuration, piping loops are installed within boreholes drilled perpendicular to the ground surface. Boreholes are typically four to six inches in diameter and 100 to 500 feet in depth, although greater depths and larger diameters are possible. Two or more lengths of pipe, which are fused at one end to create a “U” shape, are placed within each borehole and connected to larger, horizontal “header” pipes at a shallower depth. Boreholes are typically reinforced with a temporary or permanent casing to prevent the hole from collapsing during drilling. The space between the borehole wall and piping loops is filled with grout to improve heat transfer between the loop and surrounding soil or rock and protect groundwater from contamination.<sup>4</sup>

The performance of a vertical GCHP system depends primarily on the depth and number of boreholes, which are determined by the thermal characteristics of the site (e.g., ground temperature, bedrock depth, and the thermal properties of bedrock and soil above). In situ thermal testing is critical to understanding the feasibility of installing a vertical GCHP system at a specific site, as subsurface conditions can vary greatly among locations. Similar to horizontal configurations, adequate spacing

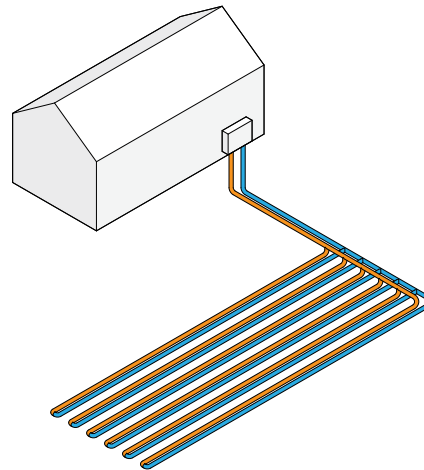

Figure A-3: Horizontal linear GCHP system

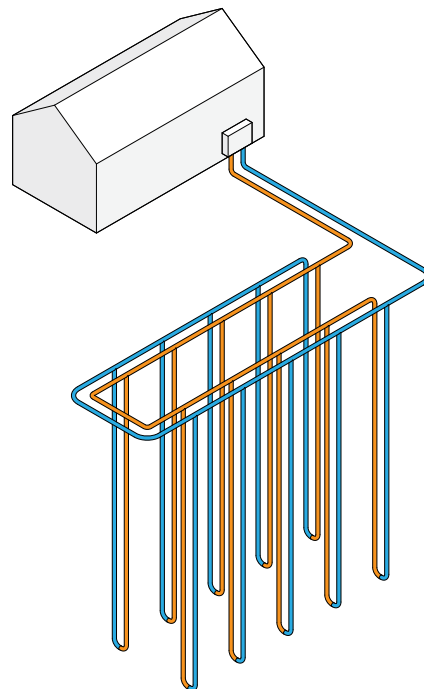

Figure A-4: Vertical GCHP system

<sup>3</sup> American Society of Heating, Refrigerating and Air-Conditioning Engineers, “Geothermal Heating and Cooling: Design of Ground-Source Heat Pump Systems (GSHP),” 2014.

<sup>4</sup> Ibid.

between boreholes is necessary to avoid thermal interference; a minimum distance of 20 to 30 feet is common.<sup>5</sup>

A vertical configuration is generally more expensive to install than a horizontal GCHP system of a similar capacity because of the costs associated with drilling. However, vertical GCHP systems are less constrained by land availability. Additionally, vertical configurations perform better than horizontal GCHP systems in colder climates because the ground temperature along each borehole remains relatively stable throughout the year.<sup>6</sup>

### 3 Groundwater Heat Pumps

A groundwater heat pump (GWHP) exchanges thermal energy with existing groundwater sources (e.g., aquifers) using one or more wells for production and injection. GWHP systems with a single well for both production and injection are referred to as “standing column wells,” whereas those with separate production and injection wells are referred to as “open-loop” systems. Unlike the closed-loop GCHP systems described in the previous Section, GWHP systems circulate groundwater rather than a water or water and antifreeze mix.

In most cases, heat exchangers are used to transfer thermal energy from the groundwater to a secondary closed loop of circulating fluid, which is then connected to a water-to-air or water-to-water heat pump within the building. In smaller applications it is possible to circulate untreated water directly through the heat pump, but this may result in the fouling or corrosion of system components.

The performance of a GWHP system depends on the well or aquifer yield, the spacing between wells where applicable, and the difference in temperature between the circulating fluid used for the heat pump and the groundwater supply; this differential is also referred to as the “approach temperature.” Groundwater drawdown, which is the difference between the existing water level and depressed water level that occurs when water is removed from the well, is a key consideration for determining well spacing. The drawdown for a given pumping rate

determines the ability of a well to deliver water, indicating the amount of power required to remove water from the aquifer.<sup>7</sup>

GWHP systems are generally less expensive to install than vertical GCHP systems of a similar capacity.<sup>8</sup> However, the feasibility of a GWHP for a given site may be limited by groundwater quality and availability and local regulations. GWHP systems require more maintenance than GCHP and closed SWHP systems. A GWHP must be sized and controlled correctly to manage pumping energy, heating and cooling performance, and operating costs. Protective measures against fouling and scaling may also be needed if the well is not properly developed or if the groundwater quality is poor. If the groundwater contains a high concentration of particulates, well screens and filters are required to limit sedimentation and maintain an appropriate flow rate.

#### 3.1 Open-Loop Systems

In a conventional open-loop GWHP system, groundwater is removed from an aquifer and pumped through an intermediate heat exchanger, which isolates the heat transfer fluid circulating through the heat pump from exposure to the groundwater. In this configuration, the circulating loop can be operated at the optimum flow rate for heat pump performance, and the groundwater at the optimum flow rate for well pump power.

A key difference between conventional open-loop and GWHP systems is that the performance of heat pumps in an open-loop system increases with groundwater flow rate. However, there is a point at which the energy required to operate the well pump outweighs the incremental gains in heat pump performance. It is therefore critical to design open-loop GWHP systems for an optimum flow rate.

As mentioned earlier in this Section, groundwater drawdown is a key consideration for spacing between production wells and injection wells, respectively. Drawdown is the result of a “cone of depression” that forms around a well when pumping occurs. The cone of depression is shaped by the increasing reduction in water pressure as it approaches the well, and its extent, known

---

5 Ibid.

6 Ibid.

7 Oregon Institute of Technology Geo-Heat Center, “Design Aspects of Commercial Open-loop Heat Pump Systems,” 2000.

8 American Society of Heating, Refrigerating and Air-Conditioning Engineers, “Geothermal Heating and Cooling: Design of Ground-Source Heat Pump Systems (GSHP),” 2014.

as the radius of influence, is determined by the composition of the aquifer, the production rate of the well, and various other factors. A similar phenomenon occurs around injection wells. In this case, “cone of injection” forms when water flows into the well, and both the water level and water pressure increases.

If multiple wells are operating in close proximity, their respective cones of depression or injection can overlap and cause significant changes in drawdown. This can affect the quantity of water available to individual production wells and alter the natural direction of groundwater flow. Inadequate spacing between production and injection wells can affect the temperature of water removed from the well, known as thermal interference, which may reduce system performance.

If a cone of depression intersects a lake, river, or other surface water body, surface water may be drawn into the aquifer. This can depress surface water levels, disturbing local watersheds and ecology. A spacing of 150 to 250 feet between production and injection wells is typically sufficient to avoid thermal interference. However, for multiple sets of production and injection wells, spacing should be determined based on aquifer yield and drawdown.<sup>9</sup>

### 3.2 Standing Column Wells

A standing column well (SCW) uses a single well for both the production and injection of groundwater, reducing the amount of area needed to install the system. SCWs were developed in New England for areas with relatively shallow bedrock that produce very little groundwater and are therefore considered unsuitable for conventional open-loop GWHP and GCHP systems.<sup>10</sup>

An SCW consists of an exterior borehole that extends into the bedrock below the water table and an interior pipe, sometimes referred to as a “porter shroud,” which is shorter than the borehole and capped with a perforated endpiece. A steel casing is used to support the exterior borehole until it reaches bedrock, after which it is self-supporting. Groundwater flows from the surrounding bedrock aquifer into the shroud and is drawn up an intake

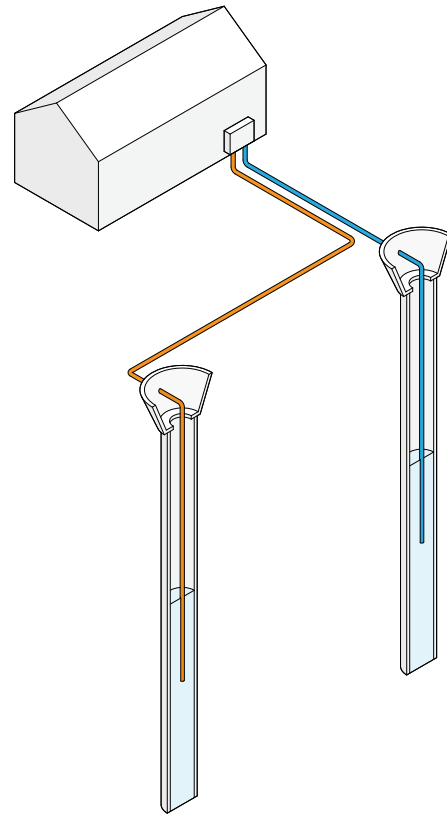

Figure A-5: Conventional open-loop GWHP system

<sup>9</sup> New York City Department of Design and Construction, “Geothermal Heat Pump Manual,” 2013.

<sup>10</sup> O’Neill et al., “Modeling of Standing Column Wells in Ground Source Heat Pump Systems,” 2006. American Society of Heating, Refrigerating and Air-Conditioning Engineers, “Geothermal Heating and Cooling: Design of Ground-Source Heat Pump Systems (GSHP),” 2014.

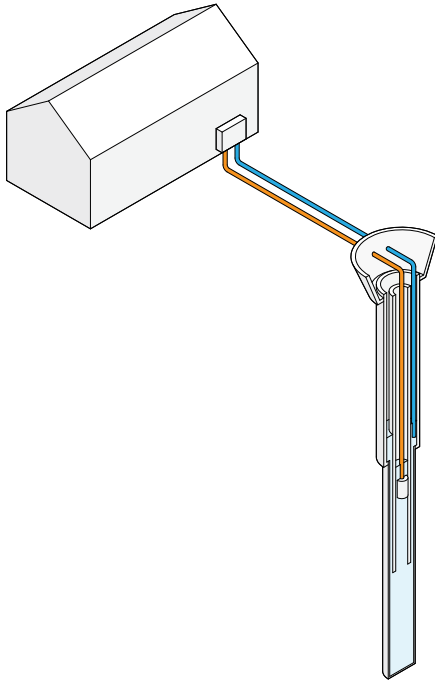

Figure A-6: Standing Column Well GWHP system

pipe to the heat pump by a submersible pump. After passing through the heat pump, water is returned to the well through a return pipe between the shroud and exterior borehole.<sup>11</sup>

SCW systems are more susceptible to water quality issues than conventional open-loop systems, as the heat pump is often directly exposed to groundwater. However, because SCW performance is relatively unaffected by drawdown, the required spacing between wells is much lower than that for conventional open-loop systems. A spacing of 50 to 75 feet between SCWs is typically sufficient to avoid thermal interference.<sup>12</sup>

## 4 Surface-Water Heat Pumps

A surface-water heat pump (SWHP) exchanges thermal energy with certain surface water bodies (e.g., lakes, ponds, rivers) that maintain a relatively stable water temperature throughout the year. SWHP systems are relatively simple, consisting of one or more heat pumps connected to a submerged network of piping in either an open- or closed-loop configuration.

The performance of horizontal closed SWHP systems depends on the temperature difference between the circulating fluid used for the heat pump and the water temperature, which itself is affected by a variety of factors. See Chapter II, Section 1.3 of this Study for a description of the factors affecting surface water thermal sources.<sup>13</sup>

### 4.1 Open-Loop Systems

Open-loop SWHP systems pump water from near the bottom of a surface water body, referred to as a reservoir, through an intermediate exchanger, similar to those used for some GWHP systems. A closed loop of piping on the other side of the heat exchanger circulates heat transfer fluid through one or more heat pumps. After passing through the intermediate heat exchanger, water is returned to the reservoir at some distance from where it was

<sup>11</sup> New York City Department of Design and Construction, "Geothermal Heat Pump Systems Manual," 2013.

<sup>12</sup> Ibid.

<sup>13</sup> The American Society of Heating, Refrigerating and Air-Conditioning Engineers report "RP-1384 -- Development of Design Tools for Surface Water Heat Pump Systems," finalized in 2017, provides improved data and procedures for the design of SWHP systems.

pumped. The reservoir pump may be located either slightly above the surface or submerged below the reservoir water level.

Open-loop SWHP systems are generally not feasible in moderate to colder climates because of the risk of freezing when the temperature of the water is less than that of the fluid leaving the heat exchanger. Ice buildup impedes heat transfer and will eventually cause the heat pump to shut down. In some cases, ice buildup may cause the pipes within the reservoir to float to the surface.

Additionally, open-loop systems can alter reservoir water temperature and quality, and depress water levels, which may negatively affect the aquatic ecosystem. Environmental issues can be addressed to some extent by controlling the intake volume of the system and maintaining a sufficient distance between intake and return points. However, it is critical that the applicable federal, state, and local surface water regulations are carefully considered in the early stages of the design process.

Installation costs for open-loop SWHP systems are generally lower than for GWHP, GCHP, and closed-loop SWHP system. However, maintenance costs are generally higher for open-loop SWHP systems because of the direct exposure of heat pump components to reservoir water. Multiple stages of filtration may be needed to remove contaminants and to avoid buildup in heat exchangers.<sup>14</sup>

## 4.2 Closed-Loop Systems

Closed-loop SWHP systems consist of one or more heat pumps connected to a submerged network of loosely-bundled HDPE piping coils, or a series of stainless steel or titanium plate heat exchangers resting at the bottom of the reservoir. Similar to GCHP systems, a heat transfer fluid, typically water mixed with a non-toxic antifreeze solution, is circulated through the piping or heat exchangers.

SWHP systems with a heat exchangers are typically intended for flowing watercourses, such as rivers and streams, although they may be installed in water bodies such as ponds and lakes. In high-flow locations, deflectors are often needed to protect the heat exchanger from debris and ice damage.

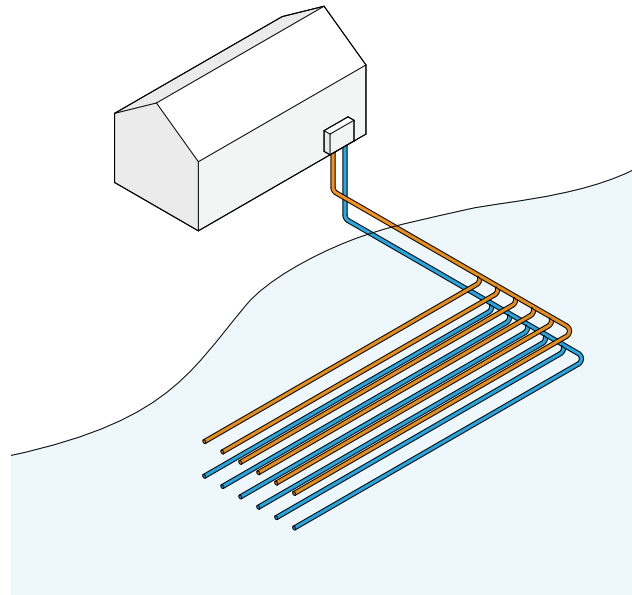

Figure A-7: Open-loop SWHP system

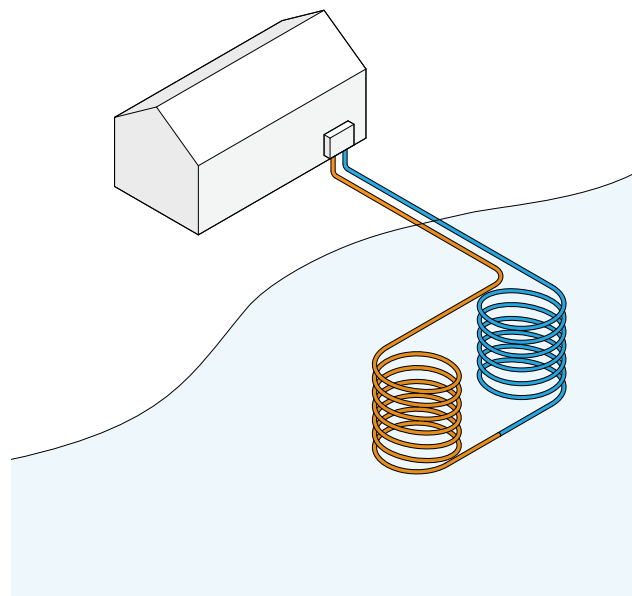

Figure A-8: Closed-loop SWHP system

<sup>14</sup> American Society of Heating, Refrigerating and Air-Conditioning Engineers, "Geothermal Heating and Cooling: Design of Ground-Source Heat Pump Systems (GSHP)," 2014.



The performance of both plate and coil configurations is susceptible to temperature fluctuations, especially in cases where the water body is small or shallow. However, unlike open-loop systems, they are not at risk of fouling or corrosion from exposure to reservoir water, and do not affect

water quality. Moreover, because they circulate an antifreeze mix, closed-loop SWHP systems can be used in moderate to cold climates, although feasibility will ultimately depend on the specific characteristics of the water body.<sup>15</sup>

---

<sup>15</sup> Ibid.

# Appendix B: Case Studies

## 1 Stockton University (Galloway Township, New Jersey)

Stockton University's GCHP system was installed in 1994 to serve the campus' heating needs. It is one of the largest systems in the country consisting of 400 425-foot deep boreholes and 64 miles of underground piping. The capital costs for installing the system were largely covered by utility rebates and state grants. The system has resulted in an estimated 25 percent reduction in electricity consumption, 70 percent reduction in natural gas consumption, and a 17 percent reduction in greenhouse gas emissions.<sup>1</sup>

Characteristics	Description
Project type	Retrofit
System type	Vertical GCHP
System capacity	1,741 tons
Buildings served	480,000 square feet (classrooms, offices, labs)
Installation cost	\$5.1 million (without rebates and incentives); \$2,929 per ton
Estimated savings	\$400,000 per year (O&M savings)
Estimated payback	6 years

## 2 West Union District System (West Union, Iowa)

In 2013, the town of West Union completed the construction of a district GCHP system designed to serve 60 downtown buildings. The district system is owned by the municipality, which leased operation rights to a user group consisting of participating building representatives.<sup>2</sup> Participating buildings were required to install their own heat pumps to use the system. Property owner investments were supported by a special low-interest loan program from two local banks, utility rebates, and USDA Rural Energy for America Program funding. Construction of the public infrastructure portion of the system (i.e., the wells and loops) cost \$2.3 million. This was entirely paid for with a HUD Community Development Block Grant, EPA Climate Showcase, and DOE funding.<sup>3</sup> According to the DOE, the total investment, including cost-shares from other federal agencies and the local utility, was \$8.7 million.<sup>4</sup>

Characteristics	Description
Project type	Retrofit
System type	Vertical GCHP
System capacity	264 tons
Buildings served	330,000 square feet
Installation cost	\$8.7 million (\$2.3 million for GCHP system), \$32,955 per ton

<sup>1</sup> National Wildlife Federation, "Going Underground on Campus: Tapping the Earth for Clean, Efficient Heating and Cooling," 2011.

<sup>2</sup> Green 13 and Public Good Initiative, "Implementing District Geoexchange Systems in Canada," 2017.

<sup>3</sup> Geerts, Jeff, "How the Town of West Union Built a Transformational Geothermal Project."

<sup>4</sup> U.S. Department of Energy, "EERE Success Story--Iowa: West Union Green Transformation Project."

### 3 Furman University (Greenville, South Carolina)

In 2014, Furman University retrofitted ten student housing buildings—nearly 40 percent of its campus student housing—with GCHP systems. The buildings contain 255 apartments serving 1,020 students. The district-scale system is comprised of 20 517-foot deep boreholes. Each building is served by individual heat pumps. The project was partially funded by a \$2.4 million DOE grant through ARRA Funding for Research and Development. The remaining cost was borne by the University through funding that was initially allocated for replacement of existing and outdated HVAC systems. The new GCHP system is expected to save 600 metric tons of CO<sub>2</sub>e annually.<sup>5</sup>

Characteristics	Description
Project type	Retrofit
System type	Vertical GCHP
Buildings served	10 student housing buildings
Installation cost	\$4.9 million
O&M cost	\$17,000 per year
Estimated Savings	\$55,000 per year
Estimated Payback	20 years

### 4 Ball State University (Muncie, Indiana)

Ball State University's main campus occupies 731 acres of land and includes more than 47 major buildings, enclosing approximately 6.5 million square feet of space for academic classrooms, administrative offices, sports facilities, and residence halls. In 2009, the University broke ground on a project to replace its coal-fired boilers and chilled water equipment with a district GCHP system. The system simultaneously produces hot water and chilled water.

Two district energy stations were constructed on opposite ends of the campus. The heat pump chillers in both stations feed hot and cold water into the original distribution system that provided heating and cooling for all major buildings on campus. The district system relies on 3,600 boreholes (400 to 500 feet deep), or about 1,100 miles of piping. The University received a \$5 million grant in 2009 from ARRA through the DOE to pursue the project. The University has offset an estimated 85,000 tons of carbon dioxide emissions annually by retiring its use of coal as a fuel source.<sup>6</sup>

Characteristics	Description
Project type	Retrofit
System type	Vertical GCHP
System capacity	152 MBtu per hour heating (~12,600 heating tons); 10,000 cooling tons <sup>7</sup>
Buildings served	5.5 million square feet
Installation cost	\$82.9 million, \$6,579 per heating ton
Estimated savings	\$2.2 million per year

5 Redderson, Jeff, "North Village Ground Source Heat Pumps Demonstration Project," 2015.

6 Ball State University, "Ground Source Geothermal District Heating and Cooling System," 2019.

7 MEP Associates, "Campus Conversion to Geothermal: Ball State University's Conversion to Campus Geothermal System," 2016.

## 5 South Caribou Recreation Centre (British Columbia, Canada)

The South Caribou Recreation Centre consists of a hockey arena, curling arena, and offices. In the early 2000s the South Caribou community decided to replace their 50-year-old hockey arena with a new facility that would use a GCHP system for heating and cooling. The large site enabled the construction of a horizontal earth loop, and the system's construction was completed in 2002. The project received \$60,000 from the Commercial Building Incentive Program from Natural Resources Canada.<sup>8</sup>

Characteristics	Description
Project type	New construction and retrofit
System type	Horizontal GCHP
System capacity	88 tons, refrigeration heat pumps (hockey and curling arena); 24 tons, heating and cooling (offices, change rooms, lobby, etc.)
Buildings served	56,400 square feet
Installation cost	\$868,000 (including incentive), \$7,750 per ton; \$105,000 (horizontal GCHP only), \$4,375 per ton
Estimate savings	\$48,000 per year
Estimated payback	2 years; 3 years without incentives

<sup>8</sup> Oregon Institute of Technology Geo-Heat Center, "Geothermal Direct-Use Case Studies," 2005.

## 6 Alexandra District Energy Utility (British Columbia, Canada)

The Alexandra District Energy Utility (ADEU) is one of the largest ambient heating and cooling district energy systems in North America.<sup>9</sup> Its construction began in 2011 and the most recent expansion was completed at the end of 2016. The system is owned and operated by the City of Richmond. It provides residential customers with space heating, cooling, and domestic hot water heating, and commercial and institutional customers with space heating and cooling.

The system will potentially serve up to 3,100 residential units and 1.1 million square feet of commercial uses at full build-out in approximately 10 to 15 years. It consists of a 11,100 foot distribution network and four networked thermal sources: GCHP systems, ASHP systems, natural gas boilers, and cooling towers. The GCHP component consists of 726 boreholes (each 250 feet deep) distributed across two well fields. The natural gas boilers are used for backup heat, and the two cooling towers provide peak cooling during the summer season. The ASHP component is housed in a satellite energy plant designed to meet the heating and cooling needs of retail spaces. The ADEU system allows for cooling heat recovery and energy sharing between buildings. The system was estimated to have avoided 2,482 tons of CO<sub>2</sub>e by the end of 2017.<sup>10</sup>

Characteristics	Description
Installation type	New construction and retrofit
Project type	Vertical GCHP
System capacity	5.8 MW heating, 7.6 MW cooling
Buildings served	1.7 million square feet
Revenue	\$1.7 million (2017); 37 percent increase from 2016
Cost of sales <sup>11</sup>	\$355,251 (2017)
Estimated Payback	20 years (8.27 percent IRR)

9 Kerr Wood Liedal, Alexandra District Energy Utility. <https://www.kwl.ca/projects/alexandra-district-energy-utility>

10 Lulu Island Energy Company, "2017 Annual Report," 2017.

11 Includes system operating costs, contract services, etc.

# Appendix B: Policies and Regulations

## 1 Federal Policies and Programs

Over the past two decades, the U.S. federal government has introduced various climate action, building electrification, and distributed generation policies. Since 2005, Congress has enacted several major energy statutes that are applicable to GSHP systems such as the Energy Policy Act of 2005; the Energy Independence and Security Act of 2007; the Energy Improvement and Extension Act, enacted as part of the Emergency Economic Stabilization Act of 2008; and the American Recovery and Reinvestment Act of 2009.

Each of these laws established, expanded, or modified energy efficiency and renewable energy research, development, demonstration, and deployment programs, and initiated several federal incentives including direct cash incentives or grants, financing options such as loans and loan guarantees, and tax incentives that are currently available for GSHP systems.<sup>1</sup>

### 1.1 Grants and Loans

The Energy Policy Act of 2005 authorized the federal government to provide loan guarantees for geothermal energy projects.<sup>2</sup> Federal grants are direct cash incentives that fund a portion of predevelopment, equipment, or installation costs for GSHP systems. Loans and loan guarantees are financing options that improve the financial feasibility of GSHP projects by distributing installation costs over time.

At a federal level, qualifying geothermal projects can receive grants and loan guarantees from:

- U.S. Department of Energy (DOE) Tribal Energy Program grants<sup>3</sup>
- DOE Office of Energy Efficiency and Renewable Energy Geothermal Technologies Program<sup>4</sup>
- U.S. Department of Agriculture (USDA) Rural Energy for America Program<sup>5</sup>
- Federal Housing Administration (FHA) PowerSaver loan program

The PowerSaver loan program in particular offers financing options for homeowners to make energy efficiency and renewable energy upgrades in their residences. Under this program, GSHP installation is considered an eligible home energy upgrade.<sup>6</sup>

### 1.2 Tax Incentives

The Energy Policy Act also established residential renewable energy tax credits, and was later extended to include geothermal heat pump systems under the Energy Improvement and Extension Act of 2008. The tax credit allows taxpayers to claim a credit of 30 percent for qualified expenditures such as labor costs, system installation, and piping for a GSHP system that serves a dwelling unit located in the U.S. that is owned and used as a residence by the taxpayer. In order to qualify, systems must be placed in service on or after January 1, 2008 and on or before December 31, 2021.<sup>7</sup>

The Energy Improvement and Extension Act also expanded business energy investment tax credits available under 26 U.S. Code § 48, to include GSHP systems. The credit was further expanded by the American Recovery and Reinvestment Act of 2009, and was most recently amended by the Bipartisan Budget Act of 2018. The credit is equal to 10 percent

1 Congressional Research Service, "Renewable Energy and Energy Efficiency Incentives: A Summary of Federal Programs," 2015.

2 U.S. Department of Energy National Renewable Energy Laboratory, "Policymakers' Guidebook For Geothermal Heating and Cooling," 2011.

3 U.S. Department of Energy, Tribal Energy Program Grant. <https://www.energy.gov/savings/tribal-energy-program-grant>

4 U.S. Department of Energy, Geothermal Technologies Office. <https://www.energy.gov/eere/geothermal/geothermal-energy-us-department-energy>

5 U.S. Department of Agriculture, Rural Energy for America Program Renewable Energy Systems & Energy Efficiency Improvement Guaranteed Loans & Grants. <https://www.rd.usda.gov/programs-services/rural-energy-america-program-renewable-energy-systems-energy-efficiency>

6 U.S. Department of Energy, FHA PowerSaver. <https://www.energy.gov/eere/solarpoweringamerica/fha-powersaver>

7 U.S. Department of Energy, Residential Renewable Energy Tax Credit. <https://www.energy.gov/savings/residential-renewable-energy-tax-credit>

of GSHP expenditures and applies to eligible property placed in service after October 3, 2008 and before December 31, 2022.<sup>8</sup>

The Modified Accelerated Cost Recovery System allows businesses to recover investments in certain types of property based on their depreciation. This incentive allows for accelerated depreciation of GSHP systems on a five-year tax schedule. GSHP systems were included under the Energy Improvement and Extension Act of 2008. Most recently, the Tax Cuts and Jobs Act of 2017 increased bonus depreciation to 100 percent for qualified property acquired and placed in service after September 27, 2017 and before January 1, 2023.<sup>9</sup>

## 2 State Policies and Programs

Massachusetts has introduced general laws, legislative acts, and bills, that support energy transition to renewable energy and distributed generation. Since the introduction of the Global Warming Solutions Act in 2008, the Massachusetts General Court has passed several acts that are relevant to clean energy and GSHP systems. These policies accelerate the state's clean energy economy through infrastructure replacement mandates, renewable and alternative energy portfolio standards, emission reduction targets, and incentive programs for residential and commercial consumers, institutions, and municipal governments.

### 2.1 General Laws

Massachusetts' General Laws are a codification of the State's statutes. Some of the relevant Acts are codified in the State's General Laws as follows: Global Warming Solutions Act (Chapter 21N, Sections 1-9, documented as the Climate Protection and Green Economy Act); Green Communities Act (Chapter 25A, Sections 1-3, 10-11, with the APS codified in Section 11F½); An Act Relative to Credit for Thermal Energy Generated with Renewable Fuels (Chapter 25A, Section 3, 11F½); and An Act to

Promote Energy Diversity (Chapter 23M, Sections 3(a)-(k)).<sup>10</sup> Other relevant general laws are described in the following subsections

#### 2.1.1 Gas energy efficiency programs (Chapter 25, §19(b))

This law authorizes the Massachusetts Department of Public Utilities (DPU) to approve and fund gas energy efficiency programs proposed by gas distribution companies including, but not limited to, demand-side management programs. Geothermal heating and cooling projects are included as eligible energy efficiency activities under this law.<sup>11</sup>

#### 2.1.2 Removal of impediments to the development of efficient low-emissions distributed generation (Chapter 164, §142)

This law mandates that the DPU continue to remove impediments to the development of efficient low-emissions distributed generation, taking into account the need to appropriately allocate any associated costs in a fair and equitable manner.<sup>12</sup>

#### 2.1.3 Plan for replacement or improvement of aging or leaking natural gas infrastructure (Chapter 164, §145(a)-(c))

This law authorizes gas companies to file with the DPU a plan to address aging or leaking natural gas infrastructure within the state in the interest of public safety and reducing lost and unaccounted for natural gas through a reduction in natural gas system leaks.

The plan must include an eligible infrastructure replacement, defined as a replacement or an improvement of existing infrastructure of a gas company that: (i) is made on or after January 1, 2015; (ii) is designed to improve public safety or infrastructure reliability; (iii) does not increase the revenue of a gas company by connecting an improvement for a principal purpose of serving new customers; (iv) reduces, or has the potential to reduce, lost and unaccounted for natural gas through a reduction in natural gas system leaks;

<sup>8</sup> U.S. Department of Energy, Business Energy Investment Tax Credit (ITC). <https://www.energy.gov/savings/business-energy-investment-tax-credit-itc>

<sup>9</sup> U.S. Department of Energy, Modified Accelerated Cost-Recovery System (MACRS). <http://programs.dsireusa.org/system/program/detail/676>

<sup>10</sup> Commonwealth of Massachusetts, General Laws Chapter 21N. <https://malegislature.gov/Laws/GeneralLaws/PartI/TitleII/Chapter21N>

<sup>11</sup> Commonwealth of Massachusetts, General Laws Chapter 25 Section 19. <https://malegislature.gov/Laws/GeneralLaws/PartI/TitleII/Chapter25/Section19>

<sup>12</sup> Commonwealth of Massachusetts, General Laws Chapter 164 Section 142. <https://malegislature.gov/Laws/GeneralLaws/PartI/TitleXXII/Chapter164/Section142>

and (v) is not included in the current rate base of the gas company as determined in the gas company's most recent rate proceeding.<sup>13</sup>

## 2.2 Legislation

Since 2008, the Massachusetts General Court has passed several pieces of legislation that are relevant to GSHP systems: An Act Establishing the Global Warming Solutions Act (2008 Acts Chapter 298); An Act Relative to Green Communities (2008 Acts Chapter 169); An Act Relative to Credit for Thermal Energy Generated with Renewable Fuels (2014 Acts Chapter 251); and An Act to Promote Energy Diversity (2016 Acts Chapter 188). These acts are key elements of the regulatory framework within which GSHP technology is adopted in Massachusetts.

### 2.2.1 Global Warming Solutions Act

The signing of the Global Warming Solutions Act of 2008 (GWSA) made Massachusetts one of the first states in the nation to move forward with a comprehensive regulatory program to address climate change. It required the State's Executive Office of Energy and Environmental Affairs (EOEEA), in consultation with other state agencies and the public, to set economy-wide greenhouse gas (GHG) emission reduction goals for the state that will achieve reductions of: between 10 and 25 percent below statewide 1990 GHG emission levels by 2020; and 80 percent below statewide 1990 GHG emission levels by 2050.<sup>14</sup>

To ensure that these goals are met, the GWSA stipulated various initiatives for the State to pursue, including but not limited to:

- Implementing reporting regulations.
- Establishing a baseline assessment of statewide GHG emissions in 1990.
- Analyzing strategies and making recommendations for adapting to climate change.

In 2016, the Massachusetts Governor signed into law Executive Order No. 569: Establishing an Integrated Climate Change Strategy for the Commonwealth,

which aims to prepare the state to adapt to and mitigate climate change on a long-term basis. It builds upon previous legislation, namely the GWSA, and mandates the creation of a statewide Comprehensive Energy Plan (CEP) among other initiatives. The Order is due to be reviewed no later than December 31, 2019, and every five years thereafter.<sup>15</sup>

### 2.2.2 Green Communities Act

The Green Communities Act of 2008 (GCA) created the Green Communities Division within the State's Department of Energy Resources (DOER). This Division aims to help municipalities become more sustainable, control rising energy costs, incubate clean energy technologies, and promote the state's clean energy economy. It offers grant opportunities to municipalities that are designated as "Green Communities." To receive this designation and the associated grant funding, municipalities must meet five criteria, including:

- Adopting a local zoning bylaw or ordinance that allows "as-of-right-siting" for renewable and/or alternative energy generation facilities.
- Adopting an expedited application and permit process for as-of-right energy facilities.
- Setting requirements to minimize lifecycle energy costs for new construction. For example, adopting the Board of Building Regulations and Standards (BBRS) Stretch Code.<sup>16</sup>

The BBRS Stretch Code is a more energy efficient code alternative for new buildings that municipalities may choose to adopt instead of the base building energy code. As of November 27, 2018, 250 municipalities in the state had adopted the Stretch Code.<sup>17</sup> The Code is performance-based, requiring new homes to meet Home Energy Rating System (HERS) index rating target. The HERS index is broadly recognized as a measure of a home's total expected energy use and overall efficiency. This means that builders have the flexibility to choose which energy efficiency measures to install, and how to design the home in order to meet the HERS

<sup>13</sup> Commonwealth of Massachusetts, General Laws Chapter 164 Section 145. <https://malegislature.gov/Laws/GeneralLaws/PartI/TitleXXII/Chapter164/Section145>

<sup>14</sup> Commonwealth of Massachusetts, Acts (2008) Chapter 298. <https://malegislature.gov/Laws/SessionLaws/Acts/2008/Chapter298>

<sup>15</sup> Commonwealth of Massachusetts, "No. 569: Establishing an Integrated Climate Change Strategy for the Commonwealth," 2016.

<sup>16</sup> Massachusetts Executive Office of Energy and Environmental Affairs, "2015 Update of the Massachusetts Clean Energy and Climate Plan for 2020," 2015.

<sup>17</sup> Commonwealth of Massachusetts, Building Energy Codes. <https://www.mass.gov/service-details/building-energy-codes>



target.<sup>18</sup> The Green Communities Act ultimately authorizes the DOER Green Communities Division to use grant funding to incentivize municipalities to adopt policies that reduce their own energy consumption and costs and help achieve siting of renewable energy installations.<sup>19</sup>

The Green Communities Act also significantly revised the state's Renewable Energy Trust Fund and Energy Efficiency Fund, which were established as public benefits funds to promote renewable energy and energy efficiency for all customer classes by the Massachusetts Legislature. In 2009, the Massachusetts Clean Energy Center (MassCEC) became the administrator of the Renewable Energy Trust Fund, which provides grants, contracts, loans, equity investments, energy production credits, bill credits, and rebates to customers. The Energy Efficiency Fund is authorized to support energy efficiency programs, including demand-side management and low-income energy programs. Efficiency programs are administered by electric utilities and municipal aggregators, with approval by a State-appointed Energy Efficiency Advisory Council.

### 2.2.3 An Act Relative to Credit for Thermal Energy Generated with Renewable Fuels

The Green Communities Act also established an Alternative Energy Portfolio Standard (APS) in addition to expanding the state's Renewable Portfolio Standard (RPS).<sup>20</sup> Like the existing Renewable Portfolio Standard (RPS), which mandates electricity suppliers to produce a specified proportion of their electricity from renewable energy sources, the APS requires that electricity suppliers meet five percent of the state's electric loads with alternative energy generating sources by 2020.<sup>21</sup>

The 2014 Act Relative to Credit for Thermal Energy Generated with Renewable Fuels expanded the definition of "alternative energy generating sources" to include facilities that generate useful

thermal energy using "naturally occurring temperature differences in ground, air, or water" (i.e., GSHP systems).<sup>22</sup> Certified alternative energy generators earn an Alternative Energy Certificate for every 3,412,000 Btu (equivalent to 1 MWh) of useful thermal energy they produce and can sell these certificates to electricity suppliers, who use them to demonstrate compliance with APS regulations.<sup>23</sup>

### 2.2.4 An Act to Promote Energy Diversity

The 2016 Act to Promote Energy Diversity authorized the Massachusetts Development Finance Agency in consultation with the DOER, to establish a Commercial Sustainable Energy Program. This program oversees the issuance of Property Assessed Clean Energy (PACE) bonds to finance energy improvements on a commercial or industrial property.<sup>24</sup>

To finance improvements, a property owner agrees to a betterment assessment on their property that repays the financing. This approach enables owners to undertake more comprehensive energy upgrades with longer payback periods of up to 20 years. Eligible improvements include energy efficiency upgrades, renewable energy installations, and the extension of existing natural gas distribution to a property. PACE program guidelines are currently in development and financing is expected to be available in 2019.<sup>25</sup>

### 2.2.5 An Act Authorizing Resiliency Measures Under Commercial Property Assessed Clean Energy (S.1825)

This bill was on the docket of the State's 190th Legislature (2017-2018), and it amended Chapter 23M, Section 1 of the General Laws to expand the definition of a commercial energy improvement to include participation in a district heating and cooling system or participation in a microgrid. The bill was referred to the Senate's committee on Telecommunications, Utilities and Energy and accompanied a study order in April 2018.<sup>26</sup>

18 Massachusetts Department of Energy Resources Green Communities Division, "2017 Stretch Energy Code," 2017.

19 Massachusetts Executive Office of Energy and Environmental Affairs, "2015 Update of the Massachusetts Clean Energy and Climate Plan for 2020," 2015.

20 U.S. Department of Energy, Renewable Portfolio Standard. <https://www.energy.gov/savings/renewable-portfolio-standard-2>

21 U.S. Department of Energy, Alternative Energy Portfolio Standard. <https://www.energy.gov/savings/alternative-energy-portfolio-standard>

22 Commonwealth of Massachusetts, Acts (2014) Chapter 251. <https://malegislature.gov/Laws/SessionLaws/Acts/2014/Chapter251>

23 Massachusetts Department of Energy Resources, "Ground Source Heat Pumps in the Massachusetts Alternative Portfolio Standard," 2017.

24 Commonwealth of Massachusetts, Acts (2016) Chapter 188. <https://malegislature.gov/Laws/SessionLaws/Acts/2016/Chapter188>

25 Massachusetts Development Finance Agency, Property Assessed Clean Energy (PACE). <https://www.massdevelopment.com/what-we-offer/key-initiatives/pace/>

26 Commonwealth of Massachusetts, Bill S.1825 190th (2017-2018). <https://malegislature.gov/Bills/190/S1825/BillHistory>

### 2.2.6 An Act Creating a Green Bank to Promote Clean Energy in Massachusetts (H.2894)

This bill is currently on the docket of the State's 191st Legislature. It introduces a new chapter in the General Laws, authorizing the creation of a Green Energy Development Bank whose responsibilities would include: evaluating and coordinating financing for energy improvements and energy technologies throughout the state; and providing loans, loan guarantees, debt securitization, insurance, portfolio insurance, and other forms of financing support or risk management for qualified energy improvements and energy technologies.<sup>27</sup>

## 2.3 Incentive Programs

Massachusetts offers various incentives and rebates that are critical to project feasibility in both residential and commercial sectors.<sup>28</sup> These incentives can include grants, loans, equity investments, energy production credits, bill and tax credits, and rebates. MassCEC and GCA grants, Alternative Energy Certificates, and PACE financing are a few examples of the state incentives available for GSHP systems.

### 2.3.1 Residential Incentives

MassCEC offers rebates to homeowners who install qualifying GSHP systems through the Residential and Small-Scale Ground-Source Heat Pump Program. The rebate program offers additional incentives to households with incomes below 120 percent of state median income.<sup>29</sup>

Mass Save, a collaborative of Massachusetts' natural gas and electric utilities, and its energy efficiency service providers, offers homeowners zero-interest loans toward qualified energy efficient home improvements with terms of up to seven years. This program also offers free home energy assessment, prior to GSHP installation.

Massachusetts sales tax is 6.25 percent of the sales price or rental charge of tangible personal property. Owners or tenants of residential property within the

state can get a credit against their personal income tax for expenses related to renewable energy source property.<sup>30</sup>

Massachusetts offers a personal income tax deduction for any income, including royalty income, received from the sale or lease of a U.S. patent deemed beneficial for energy conservation or alternative energy development by the DOER, and any income received from the sale or lease of personal or real property or materials manufactured in Massachusetts and subject to the approved patent.<sup>31</sup>

### 2.3.2 Commercial Incentives

MassCEC rebates noted previously, are also applicable to commercial, institutional, and non-profit properties provided that the GSHP system has a heating capacity under 120,000 Btu per hour. These commercial rebates fall under MassCEC Small-Scale GSHP Program.<sup>32</sup>

MassCEC offers grants to install large-scale GSHP systems at commercial, public, non-profit, agricultural, and multifamily properties through the Commercial-Scale Ground-Source Heat Pump Program. The sales tax exemption and patent income tax deduction previously noted are available for corporate entities as well.

## 3 Regulations and Permitting

Federal and state agencies that regulate the installation and operation of GSHP systems include the U.S. Environmental Protection Agency (EPA) and the Massachusetts Department of Environmental Protection (MassDEP) Bureau of Resource Protection (BRP). MassDEP and EPA administer various environmental permitting processes for well drilling, and water withdrawal and discharge, which can limit GSHP system size and site selection. MassDEP also provides design guidelines for locating and sizing GSHP systems, as discussed below.

27 Commonwealth of Massachusetts, Bill H.2894 191st (Current). <https://malegislature.gov/Bills/191/H2894>

28 Massachusetts Clean Energy Center, Learn About Ground-Source Heat Pumps. <https://www.masscec.com/clean-heating-and-cooling/learn-about-ground-source-heat-pumps>

29 Massachusetts Clean Energy Center, "Residential and Small-Scale Ground-Source Heat Pump Program Manual," 2018.

30 Mass Save, Mass Save HEAT Loan. <https://www.masssave.com/en/saving/residential-rebates/heat-loan-program>

31 U.S. Department of Energy, Alternative Energy and Energy Conservation Patent Income Tax Deduction (Personal). <https://www.energy.gov/savings/alternative-energy-and-energy-conservation-patent-income-tax-deduction-personal>

32 Massachusetts Clean Energy Center, "Commercial-Scale Ground-Source Heat Pump Program Manual," 2018.

Table C-1: Residential Incentives in Massachusetts

Incentive	Amount	Expires
MassCEC Rebate	Up to \$10,000	Dec. 2020
Mass Save HEAT Loan	0% for 7 years; up to \$25,000	Ongoing
Mass. Sales Tax Exemption	100%	Ongoing
Mass. Patent Income Tax Deduction	100%	Ongoing

Table C-2: Commercial Incentives in Massachusetts

Incentive	Amount	Expires
MassCEC Grant	Up to \$250,000	Dec. 2020
Mass. Sales Tax Exemption	100%	Ongoing
Mass. Patent Income Tax Deduction	100%	Ongoing

### 3.1 Underground Injection Control

Underground injection control regulations may be applicable to the following GSHP systems:

- Vertical Open Loop GWHP
- Standing Column Well GWHP
- Horizontal Closed Loop SWHP
- Horizontal Open Loop SWHP

Under the purview of the Safe Drinking Water Act (SDWA), the EPA's national UIC Program regulates all artificial introductions of fluid into the Earth's subsurface, with the intention of preserving and protecting underground water from becoming polluted.<sup>33</sup>

In Massachusetts, 310 CMR 27.00 (Underground Injection Control Regulations) regulates the administration of the program.<sup>34</sup> It requires that the owner or operator of a GSHP well or trench register with the MassDEP UIC Program (per 310 CMR 27.05 (2)(a) and 310 CMR 27.08 (1)) unless the GSHP system requires permitting under the MassDEP Groundwater Discharge Program. Prior to the

construction of a GSHP system, the owner, operator, or installer must submit to the MassDEP UIC Program a completed BRP WS 06 UIC Registration application and receive an approval notice from the Agency.

Under this program, discharge wells for GSHP systems are classified as Class V injection wells, which indicates that they have been determined not to pose a significant threat to the environment if installed, operated, and decommissioned properly. There are three types of GSHP wells within the Class V program: GSHP Return Flow Wells (Major), GSHP Return Flow Wells (Minor), and Groundwater Aquaculture Return Flow Wells.

The type and operational details of GSHP wells, determines the permits, registration, and notifications required for the GSHP project. For example, all open loop GSHP wells must complete and submit raw and discharge water laboratory analyses to finalize their application for UIC registration.<sup>35</sup>

<sup>33</sup> Massachusetts Department of Environmental Protection and Bureau of Resource Protection, "Guidelines for Ground Source Heat Pump Wells," 2013.

<sup>34</sup> Commonwealth of Massachusetts, Underground Injection Control (UIC). <https://www.mass.gov/underground-injection-control-uic>

<sup>35</sup> Ibid.

## 3.2 Well Driller Certification

Well driller certifications may be required for installation of the following GSHP systems:

- Vertical Closed Loop GCHP
- Vertical Open Loop GWHP
- Standing Column Well GWHP

Only Massachusetts Registered Well Drillers are permitted to construct, alter, or decommission drilled wells for GSHP systems. UIC Program registrants must indicate GSHP system designer, installer, and MassDEP certified well driller in their applications.<sup>36</sup>

## 3.3 Groundwater Discharge

Groundwater discharge permits may be required for the following GSHP systems:

- Vertical Open Loop GWHP
- Standing Column Well GWHP
- Horizontal Open Loop SWHP

As previously mentioned, any GSHP system that receives a Groundwater Discharge Permit from MassDEP is not required to obtain a UIC Registration approval. Open loop GSHP systems that introduce chemical additives to the discharged water need to be permitted through this program per 314 CMR 5.05 (5). Any surface discharge of GSHP wastewater that completely infiltrates into the ground prior to reaching a surface water body requires a Groundwater Discharge permit.

GWHP systems discharge a portion of wastewater (called the system bleed) to a different aquifer or surface water body from which it was withdrawn in order to control the temperature of the well. If system bleed is discharged to a sewer or municipal stormwater system, the system owner, operator, or installer must submit to MassDEP either a copy of a letter or a permit from the applicable authority that indicates its approval of the discharge.<sup>37</sup>

## 3.4 Water Management Act

A permit application pursuant to the Massachusetts Water Management Act may be required for the following GSHP systems:

- Vertical Open Loop GWHP
- Standing Column Well GWHP
- Horizontal Open Loop SWHP

Water withdrawals that constitute non-consumptive use are exempt from the need to file a registration statement or a permit application pursuant to the Massachusetts Water Management Act (MGL c. 21 G. or 31 CMR 36.00).<sup>38</sup> Non-consumptive use is defined as any use of water that results in its discharge back into the same water source, at or near the withdrawal point, without substantially impairing water quantity and quality. GSHP systems generally meet this criterion.<sup>39</sup>

## 3.5 National Pollutant Discharge Elimination System

EPA National Pollutant Discharge Elimination System (NPDES) may apply to the following GSHP systems:

- Vertical Open Loop GWHP
- Standing Column Well GWHP
- Horizontal Closed Loop SWHP
- Horizontal Open Loop SWHP

These regulations apply to the surface water discharge of GSHP wastewater. Any discharge of GSHP wastewater to a jurisdictional surface water body requires an NPDES Non contact Cooling Water General Permit (NCCWGP). The requirement also applies to a GSHP if it discharges wastewater to a stormwater system that in turn discharges to a jurisdictional surface water body.<sup>40</sup> The permit establishes eligibility conditions, notice of intent requirements, effluent limitations, standards, prohibitions, and best management practices for systems and facilities discharging non contact cooling water.<sup>41</sup>

<sup>36</sup> Massachusetts Department of Environmental Protection and Bureau of Resource Protection, "Guidelines for Ground Source Heat Pump Wells," 2013.

<sup>37</sup> Ibid.

<sup>38</sup> Massachusetts Department of Environmental Protection, "Massachusetts Water Resources Management Program," 2014.

<sup>39</sup> Massachusetts Department of Environmental Protection and Bureau of Resource Protection, "Guidelines for Ground Source Heat Pump Wells," 2013.

<sup>40</sup> Ibid.

<sup>41</sup> United States Environmental Protection Agency, Noncontact Cooling Water General Permit (NCCW GP) for Massachusetts & New Hampshire. <https://www.epa.gov/npdes-permits/noncontact-cooling-water-general-permit-nccw-gp-massachusetts-new-hampshire>

# Acronyms and Abbreviations

APS: Alternative energy portfolio standards  
ARRA: American recovery and reinvestment act  
ASHP: Air-source heat pump  
BBRS: Board of Building Regulations and Standards  
Btu: British thermal units  
CHP: Combined heat and power  
COP: Coefficient of performance  
DOE: United States Department of Energy  
DOER: Massachusetts Department of Energy Resources  
DPU: Massachusetts Department of Public Utilities  
EFLH: Equivalent full load hours  
EER: Energy efficiency ratio  
EPA: Environmental Protection Agency  
EUI: Energy use intensity  
GCA: Green communities act  
gpm: Gallons per minute  
GCHP: Ground-coupled heat pump  
GWHP: Ground-water heat pump  
GWSA: Global warming solutions act  
GSHP: Ground-source heat pump  
HUD: Department of Housing and Urban Development  
HDPE: High density polyethylene  
HERS: Home energy rating system  
HVAC: Heating, ventilation, and air-conditioning  
IRR: Internal rate of return  
MassCEC: Massachusetts Clean Energy Center  
MassDEP: Massachusetts Department of Environmental Protection  
NCCWGP: NPDES non-contact cooling water general permit  
NPDES: National pollutant discharge elimination system  
O&M: Operations and Maintenance  
PACE: Property assessed clean energy  
ROW: Right-of-way  
RPS: Renewable portfolio standards  
SCW: Standing column well  
SWHP: Surface water heat pump  
USDA: United States Department of Agriculture  
VDI: Verein Deutscher Ingenieure

**HEET**

21 Acorn Street  
Cambridge, MA 02139

[heetma.org](http://heetma.org)

**BuroHappold Engineering**

100 Broadway  
New York, NY 10005  
11 Beacon Street #400  
Boston, MA 02108

[burohappold.com](http://burohappold.com)



Attribution-NonCommercial-ShareAlike 4.0 International



**BUROHAPPOLD**  
**ENGINEERING**